



CS231n: Deep Learning for Computer Vision

Lecture 1: Introduction

Welcome to CS231n



Welcome to CS231n

Course Instructors



Fei-Fei Li Andrej Karpathy

Teaching Assistants



Johnson Yuke Zhu Brett Kuprel Ben Poole

2015

Course Instructors



Fei-Fei Li Andrej Karpathy

Teaching Assistants



Serena Young Subhro Das Steven Chen Albert Mokht Steven Srinivasa



Justin Johnson Huo Phan Inwan Bello Namrata Anand Lane McIntosh Catherine Dong



Kyle Genova

2016

Instructors



Fei-Fei Li



Justin Johnson



Serena Young

Teaching Assistants



Albert Haque (Head TA)



Charanya Aulawa



Josh Beal



Vincent Chen



Edward Chou

John Clow



Manik Dhar



Jimi (Linxo) Fan



Alexander (Kayu) Fu



Pedro Pablo Gonzalez

Michelle Guo



Jingwei Huang



Carclyn Kim



Winnie Lin



Bingbin Liu

Xingyu Liu



Ajay Mandekar



Amari Peddada



Mike Roberts



Praty Sharma

Fei Xia



Danfei Xu



Ben Zhang

2018

Instructors



Fei-Fei Li



Justin Johnson



Serena Young

Teaching Assistants



Albert Haque (Head TA)



Rishi Bedi



Agrim Gupta



De-An Huang



Russell Kaplan



Leo Keselman



Nishith Khandwala



Xingyu Liu



Shayne Longpre



Shyamal Buch



Zhao (Joe) Chen



Lane McIntosh



Luda Zhao



Amari Peddada



Boqi (Erina) Peng



Ben Poole



Justin Johnson



Luda Zhao

2017

Instructors



Fei-Fei Li



Justin Johnson



Serena Young

Teaching Assistants



Winnie Lin (Head TA)



Saahil Agrawal



Malavika Bindi



Haoye Cai



Kaidi Cao



Apoorva Dornakula



Jim (Linxo) Fan



Ayush Gupta



Andrew Han



Tian-Ning Hsu



Lars Jobe



Nishith Khandwala



Simon Le Cleach



Bingbin Liu



David Morales



Zaid Nabussi



Boqiao Pan



Ashwini Pote



Praty Sharma



William Shen



Owen Wang



Danfei Xu

2019

Instructors



Fei-Fei Li



Ranjay Krishna



Danfei Xu



Anelle Syun

Teaching Assistants



William Shen (Head TA)



Andrew Kondrich



Lyne P. Tchapira



Brent Yi



Jonathan Brasz



Fang-Yu Lin



Chris Waltes



Christina Yuan



Daniel Cai



Damian Mrowca



Rui Wang



Kevin Zakka



JunYoung Gwak



Boxiao Pan



Yi Wen



Yifeng Zhang



De-An Huang



Nishant Rai



Karen Yang



Yifeng Zhang

2020

Instructors



Fei-Fei Li



Ranjay Krishna



Danfei Xu

Teaching Assistants



Kevin Zakka (Head TA)



Sean Lu



Guanzhi Wang



Haofeng Chen



Mandy Lu



Chris Waltes



Rachel Gardner



Nishant Rai



Jequan Zhang



Samuel Kwong



Geet Sethi



Russel Xie



Yichen Li



Lin Shao

2021

Artificial Intelligence

Slide inspiration: Justin Johnson

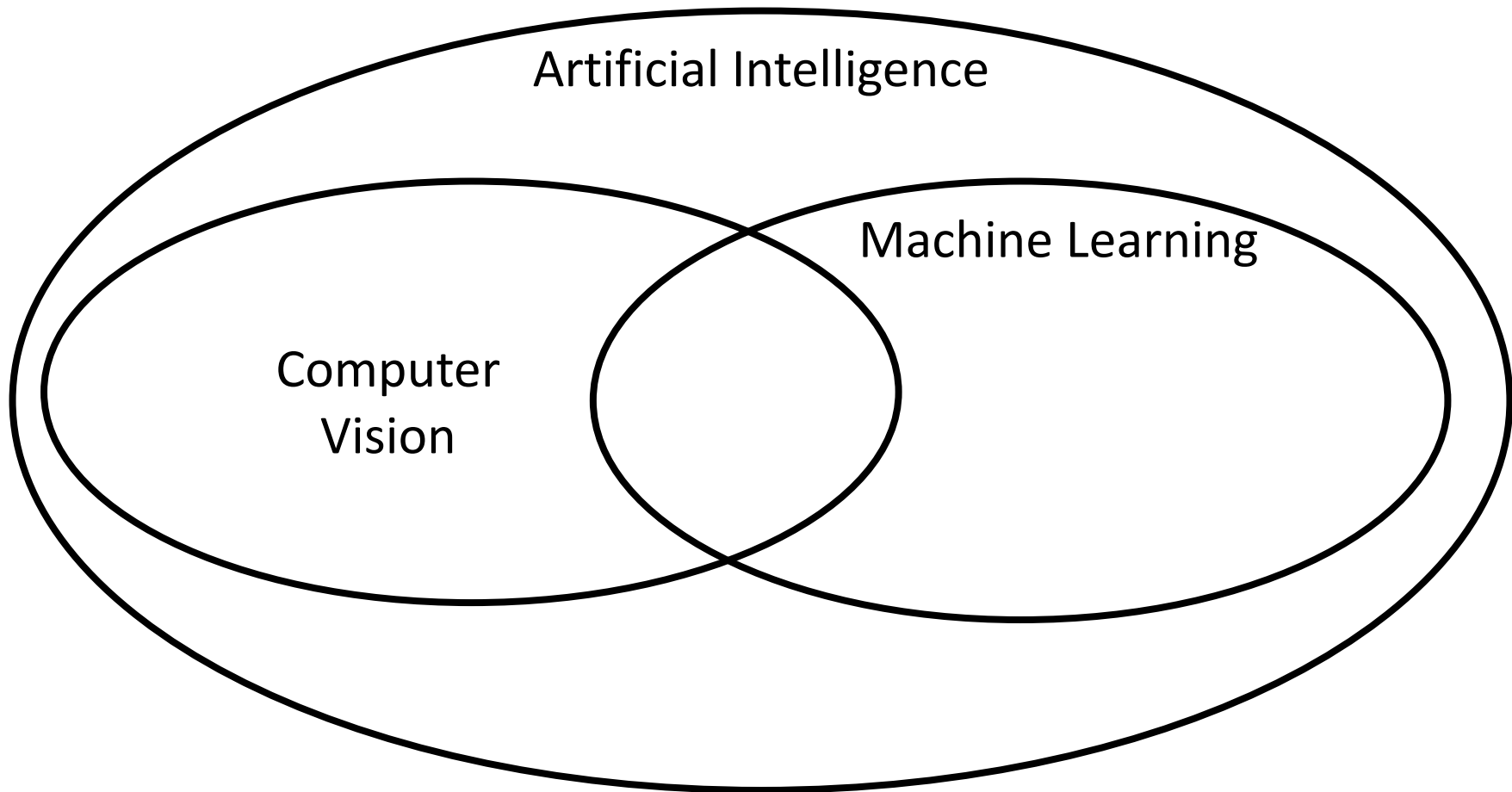

Slide inspiration: Justin Johnson

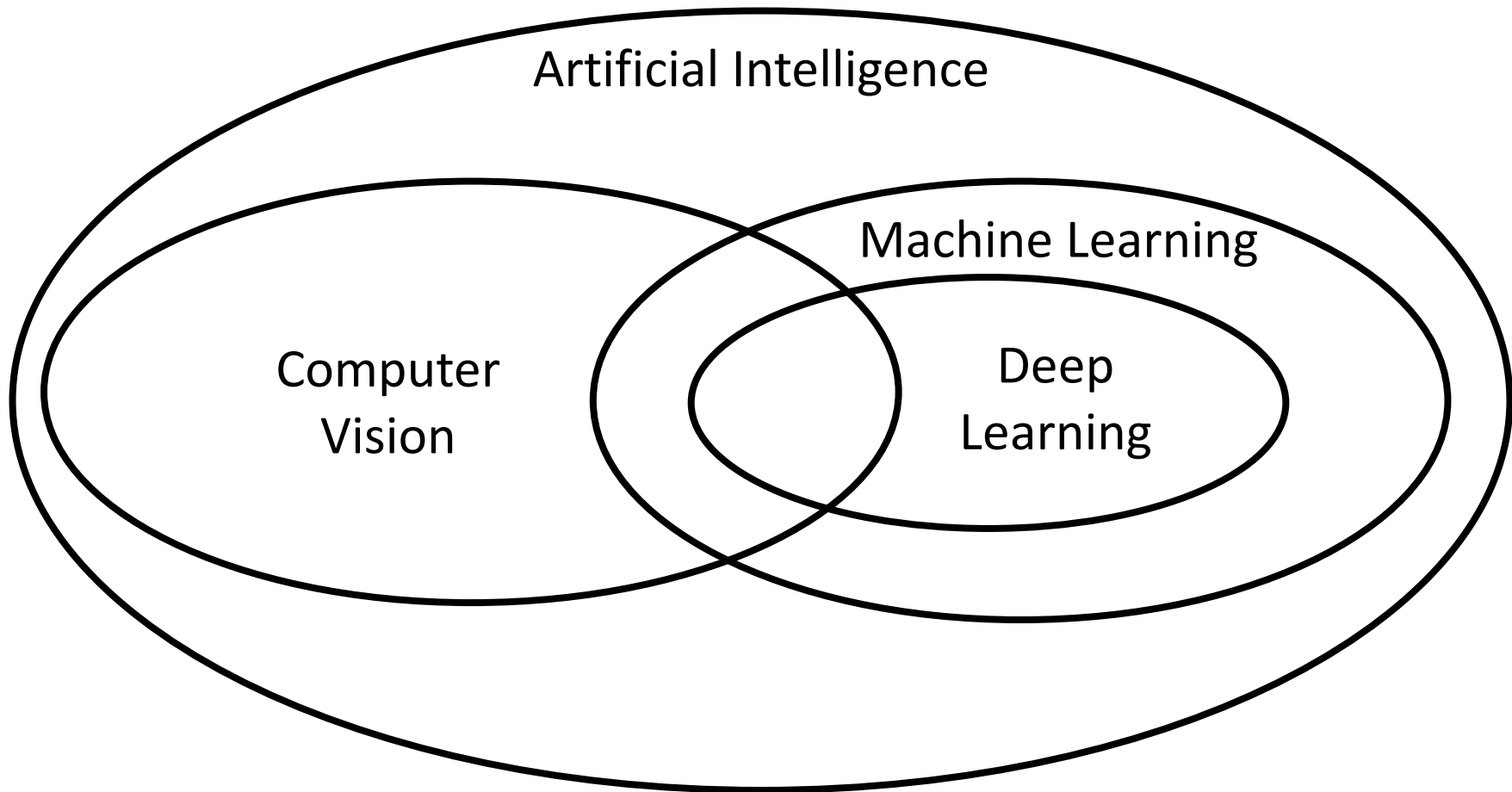

Slide inspiration: Justin Johnson

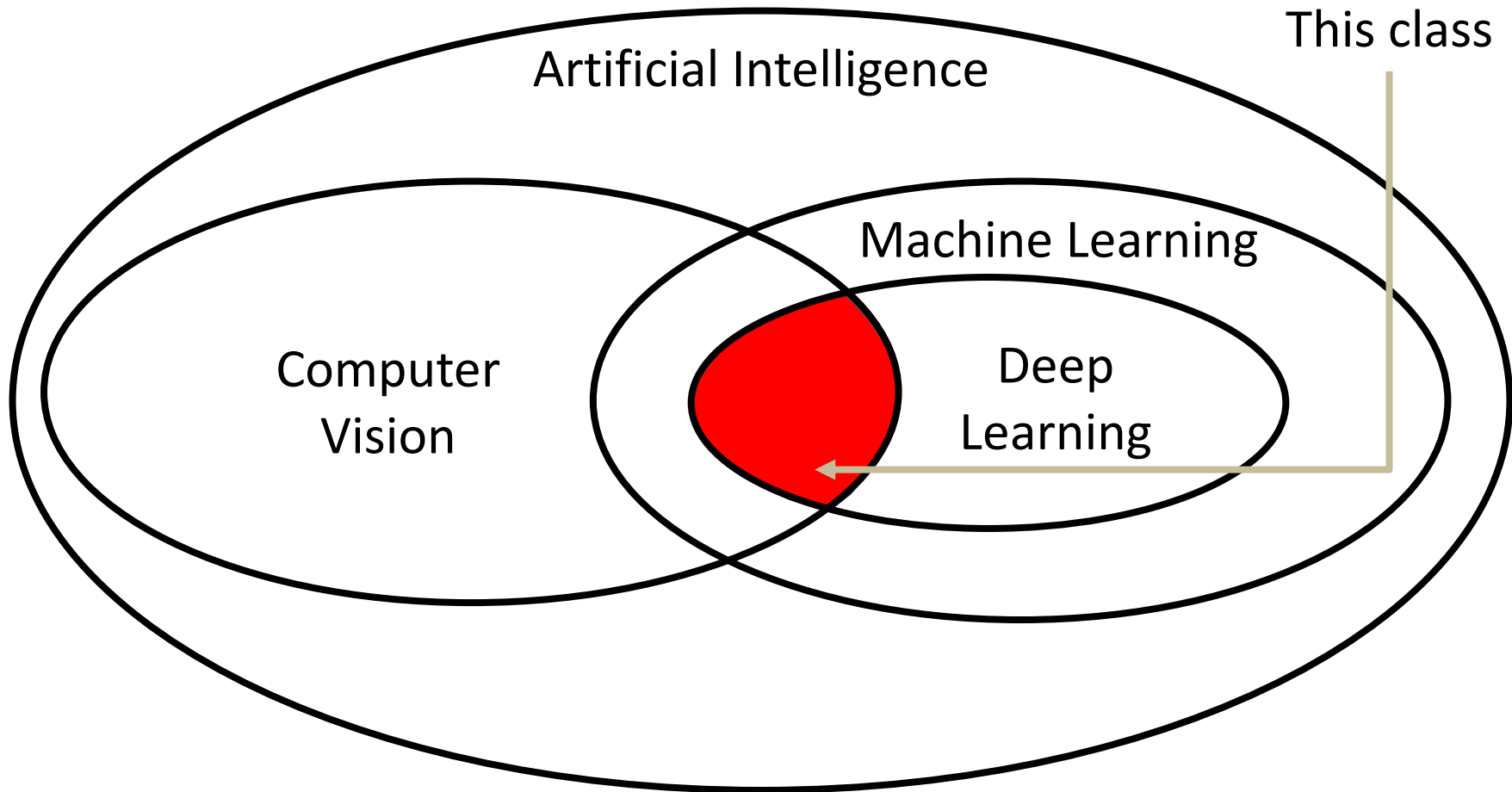

This class

Artificial Intelligence

Machine Learning

Computer
Vision

Deep
Learning

Slide inspiration: Justin Johnson

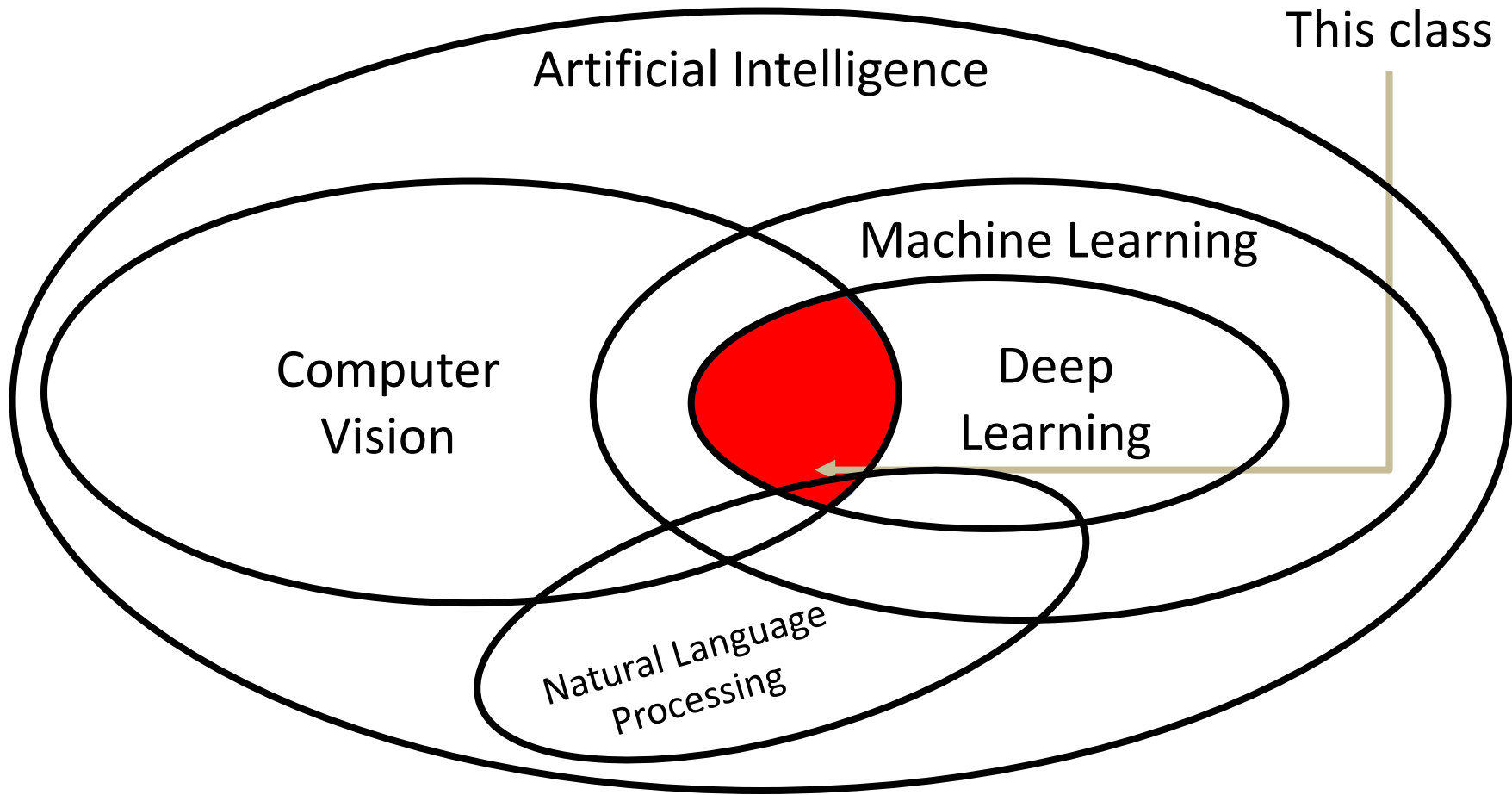

Slide inspiration: Justin Johnson

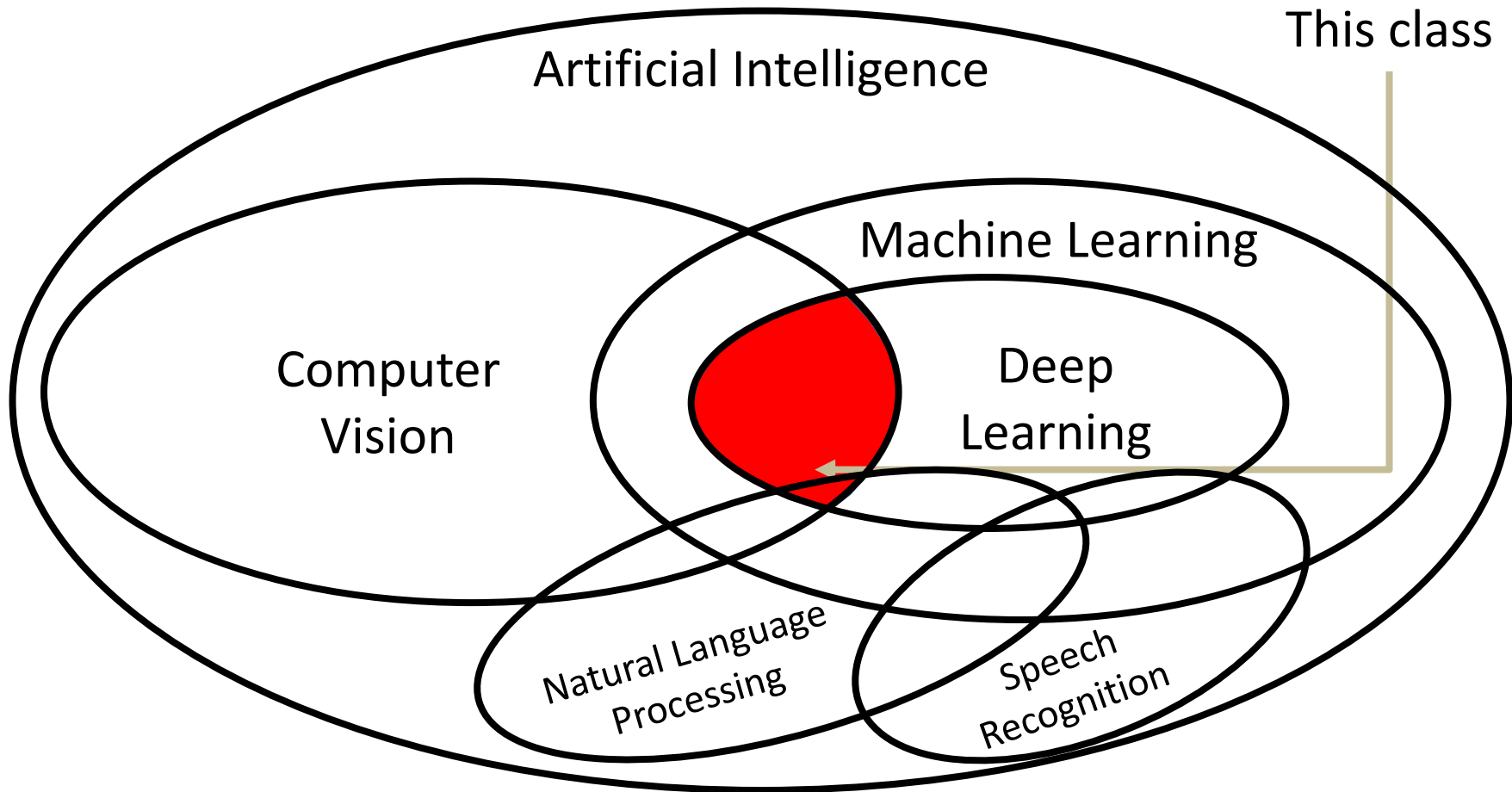

Slide inspiration: Justin Johnson

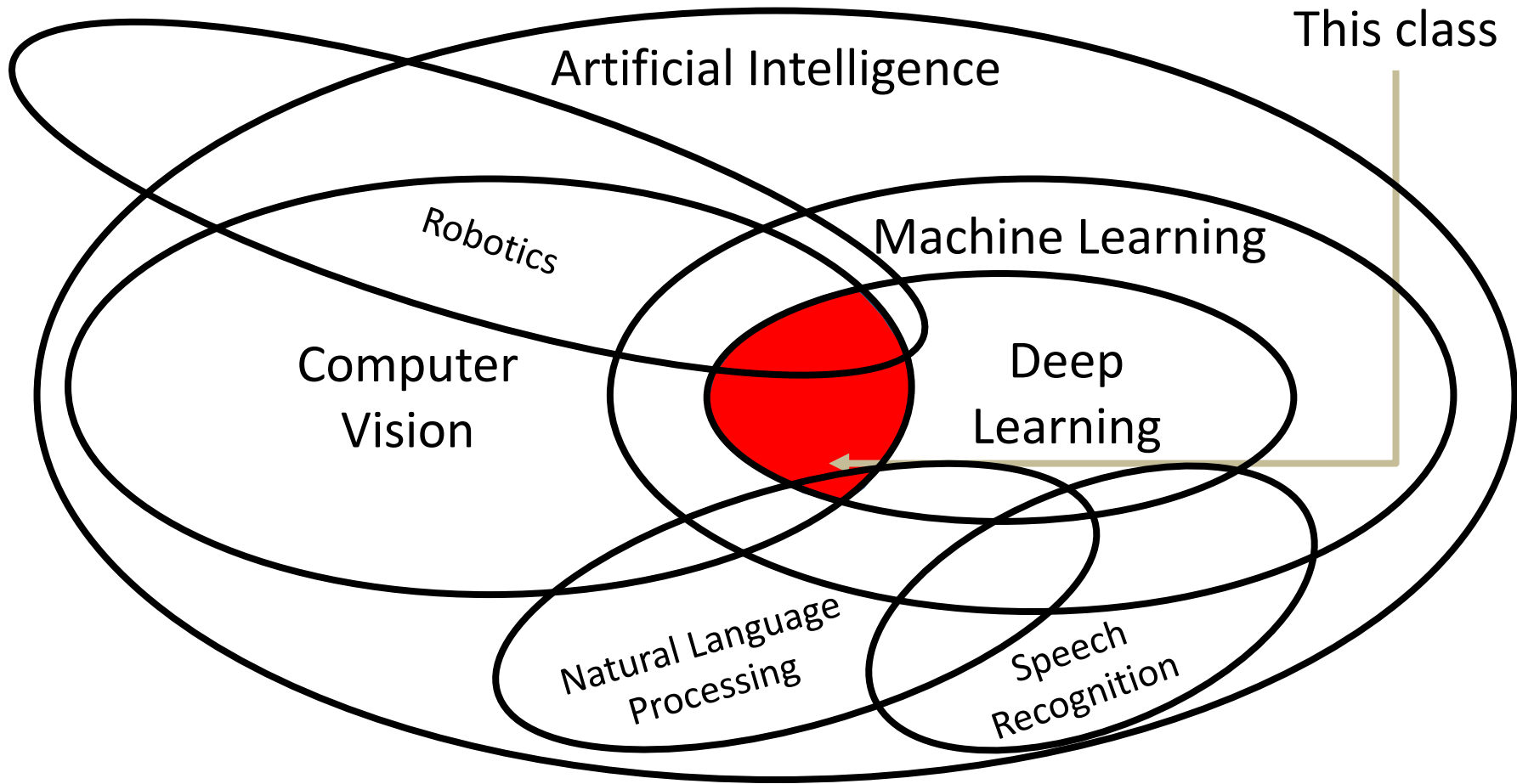

This class

Slide inspiration: Justin Johnson

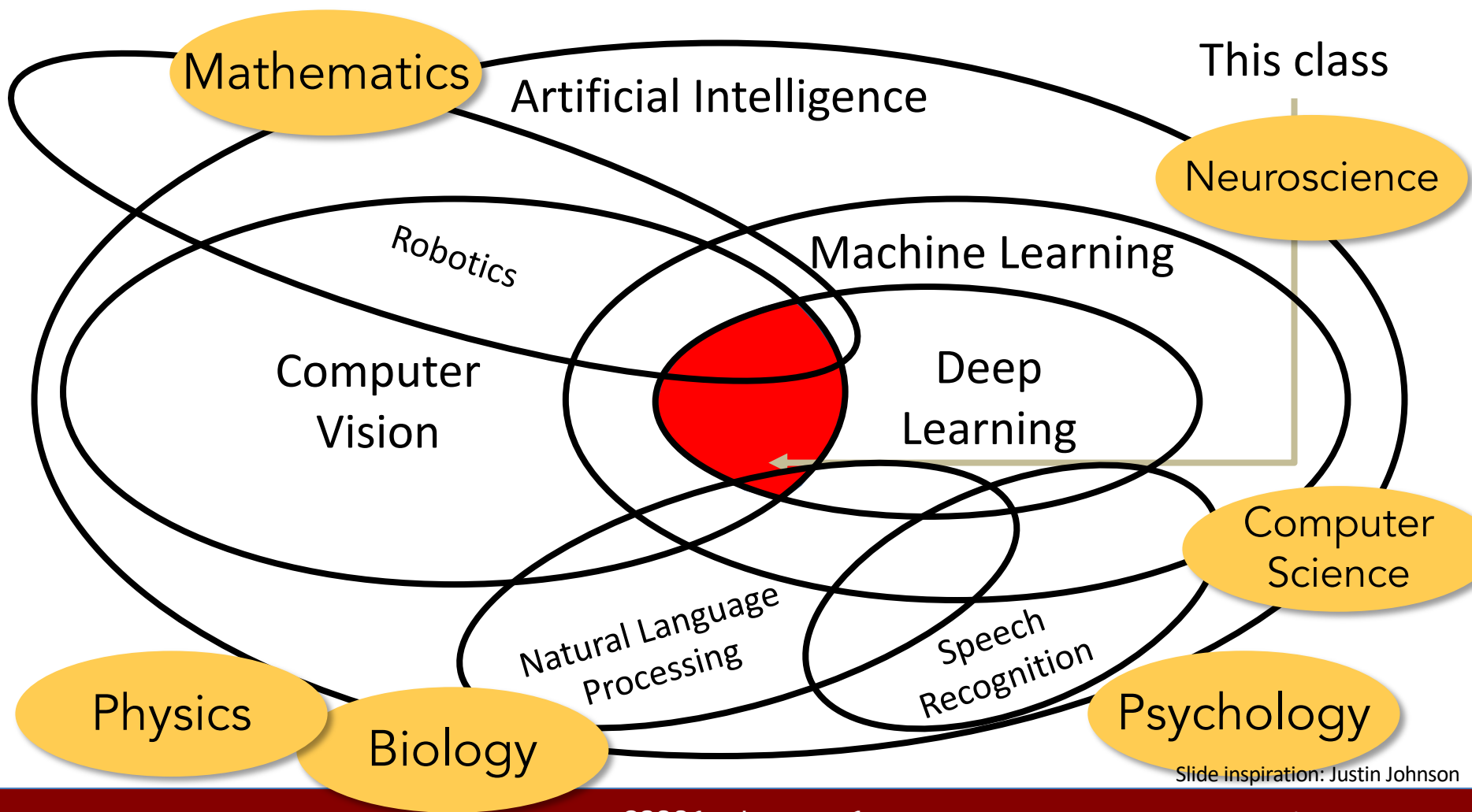

Today's agenda

- A brief history of computer vision and deep learning
- CS231n overview

Evolution's Big Bang: Cambrian Explosion, 530-540million years, B.C.



[This image](#) is licensed under [CC-BY 2.5](#)



[This image](#) is licensed under [CC-BY 2.5](#)

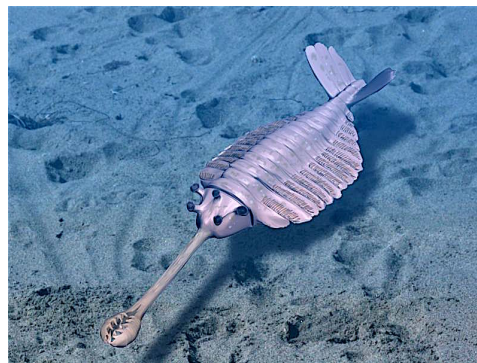

[This image](#) is licensed under [CC-BY 3.0](#)



Camera Obscura

Gemma Frisius, 1545

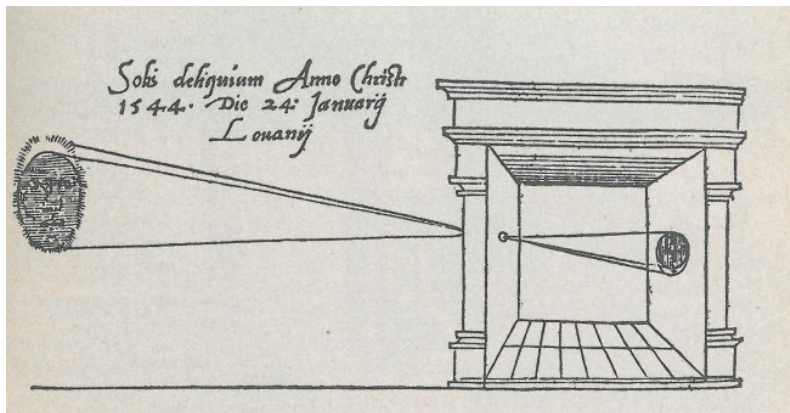

This work is in the public domain

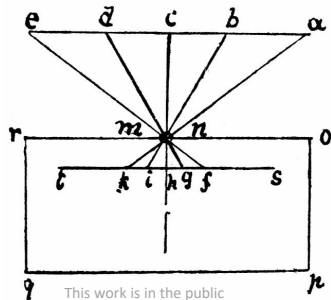

This work is in the public domain

Leonardo da Vinci,
16th Century AD

Encyclopedia, 18th Century

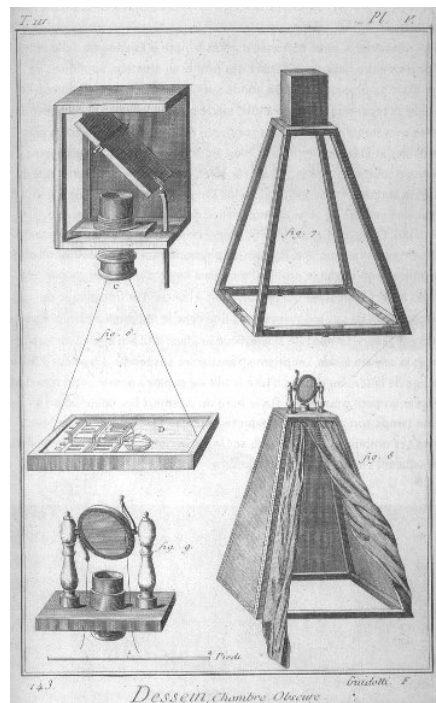

This work is in the public domain

Computer Vision is everywhere!

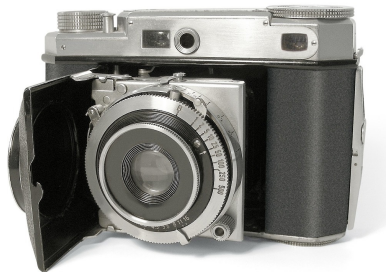

Left to right:
[image](#) by [Roger H Goun](#) is licensed under [CC BY 2.0](#)
[image](#) is [CC0 1.0](#) public domain
[image](#) is [CC0 1.0](#) public domain
[image](#) is [CC0 1.0](#) public domain



Left to right:
[image](#) is [free to use](#)
[image](#) is [CC0 1.0](#) public domain
[image](#) by [NASA](#) is licensed under [CC BY 2.0](#)
[image](#) is [CC0 1.0](#) public domain

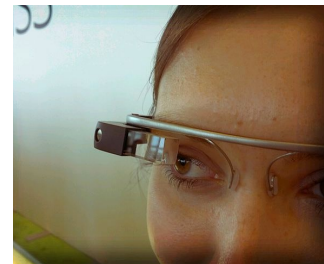

Bottom row, left to right
[image](#) is [CC0 1.0](#) public domain
[image](#) by [Derek Keats](#) is licensed under [CC BY 2.0](#); changes made
[image](#) is public domain
[image](#) is licensed under [CC BY 2.0](#); changes made

Where did we come from?

Hubel and Wiesel, 1959

Measure
brain activity



Cat image by CNX OpenStax is licensed under CC BY 4.0; changes made

1959
Hubel & Wiesel

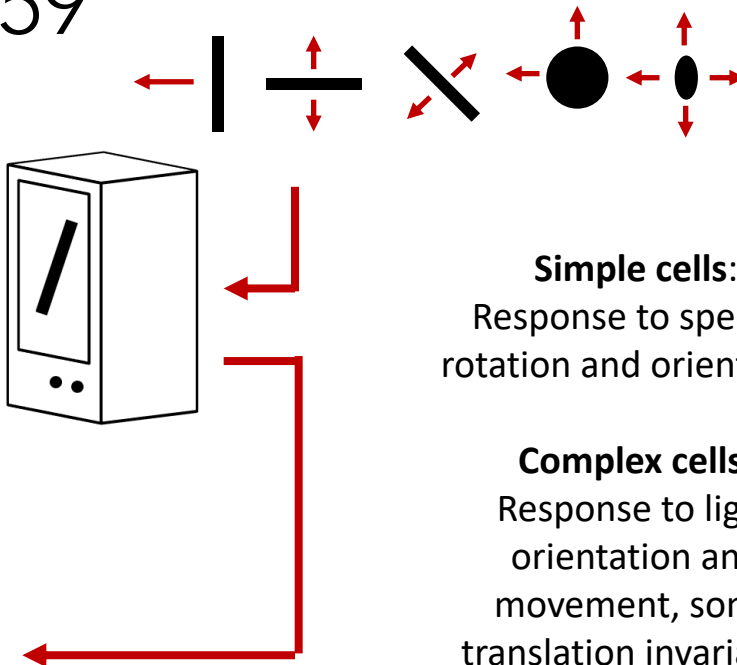
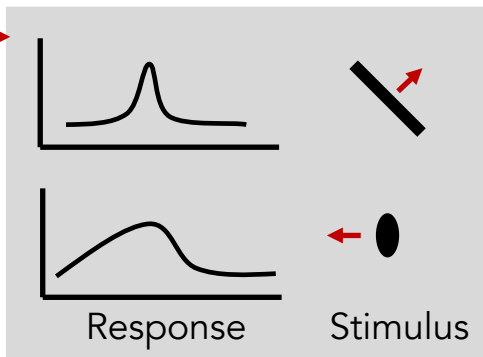

Simple cells:
Response to specific
rotation and orientation

Complex cells:
Response to light
orientation and
movement, some
translation invariance



No
response

Slide inspiration: Justin Johnson

Larry Roberts, 1963

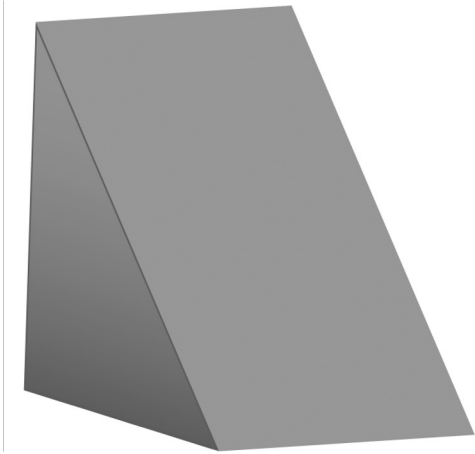

(a) Original picture

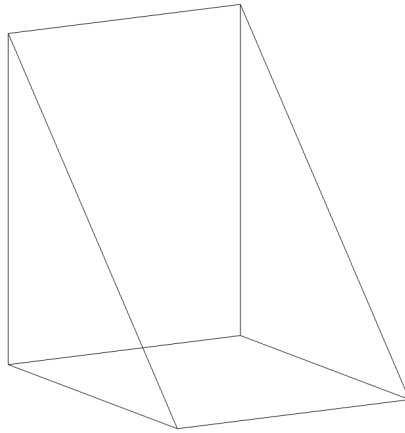

(b) Differentiated picture

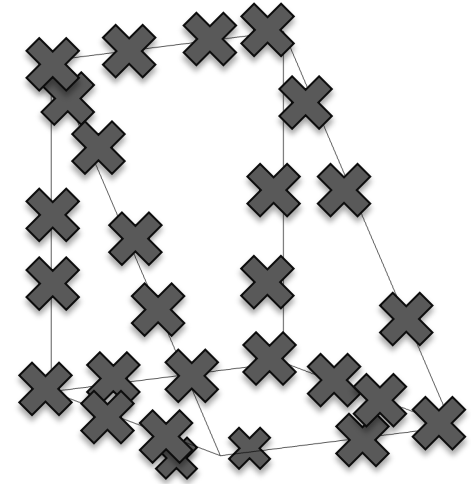

(c) Feature points selected

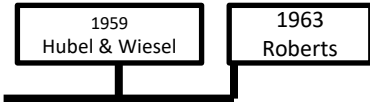

MASSACHUSETTS INSTITUTE OF TECHNOLOGY
PROJECT MAC

Artificial Intelligence Group
Vision Memo. No. 100.

July 7, 1966

THE SUMMER VISION PROJECT

Seymour Papert

The summer vision project is an attempt to use our summer workers effectively in the construction of a significant part of a visual system. The particular task was chosen partly because it can be segmented into sub-problems which will allow individuals to work independently and yet participate in the construction of a system complex enough to be a real landmark in the development of "pattern recognition".

1959
Hubel & Wiesel

1963
Roberts

<https://dspace.mit.edu/handle/1721.1/6125>

Slide inspiration: Justin Johnson

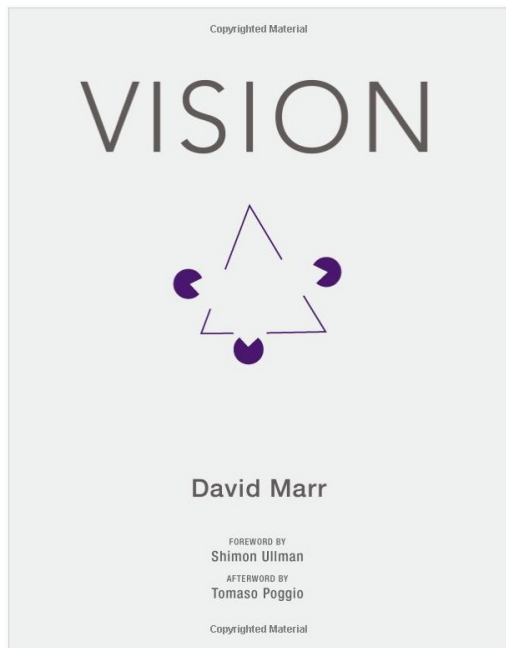

Input image



This image is [CC0 1.0](#) public domain

Edge image

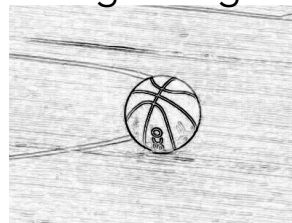

2 1/2-D sketch

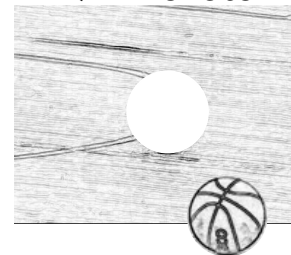

3-D model

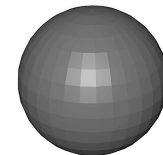

This image is [CC0 1.0](#) public domain

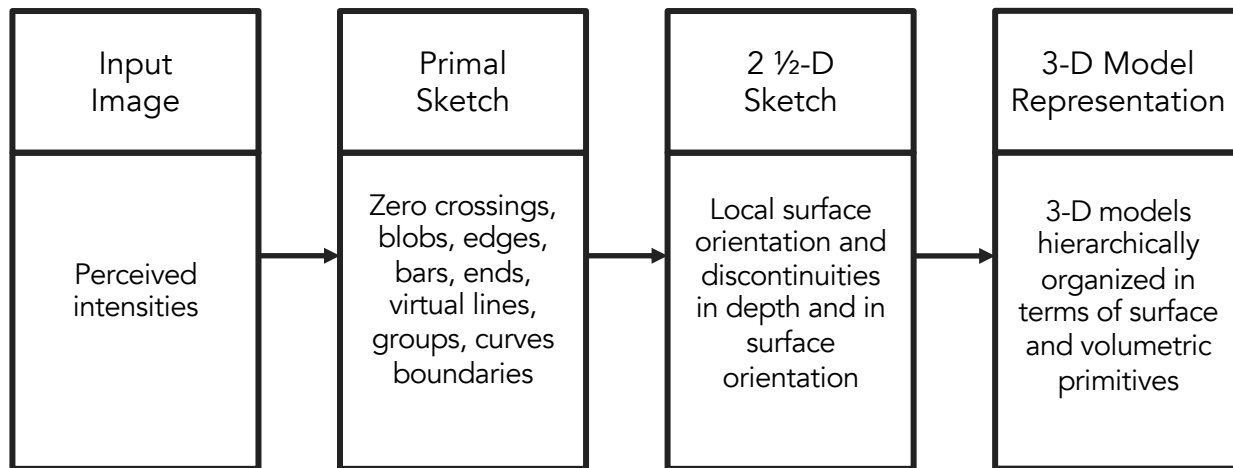

Stages of Visual Representation, David Marr, 1970s

Slide inspiration: Justin Johnson

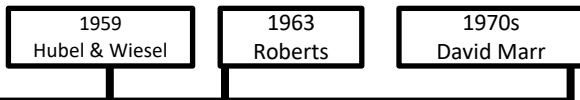

Recognition via Parts (1970s)

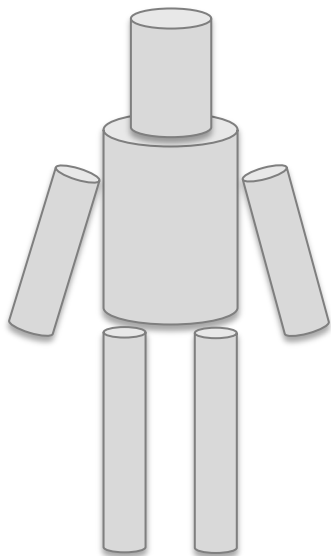

Generalized Cylinders,
Brooks and Binford,
1979

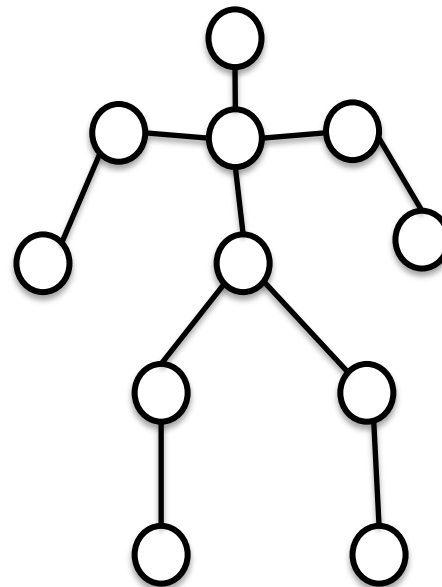

Pictorial Structures,
Fischler and Elshlager, 1973



Slide inspiration: Justin Johnson

Recognition via Edge Detection (1980s)



1959
Hubel & Wiesel

1963
Roberts

1970s
David Marr

1979
Gen. Cylinders

1986
Canny

John Canny, 1986
David Lowe, 1987

Image is [CC0 1.0](#) public domain

Slide inspiration: Justin Johnson

Arriving at an “AI winter”

- Enthusiasm (and funding!) for AI research dwindled
- “Expert Systems” failed to deliver on their promises
- But subfields of AI continues to grow
 - Computer vision, NLP, robotics, compbio, etc.

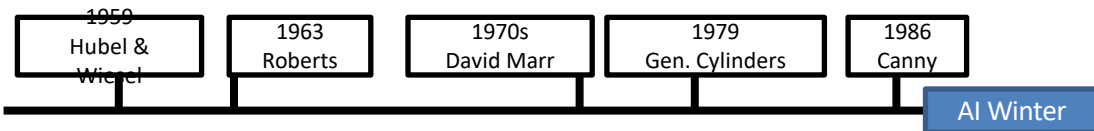

Left Image is CC BY 3.0

Middl Image is public domain

Right Image is CC-BY 2.0; changes made

Slide inspiration: Justin Johnson

In the meantime...seminal work in
cognitive and neuroscience

Perceiving Real-World Scenes

Irving Biederman

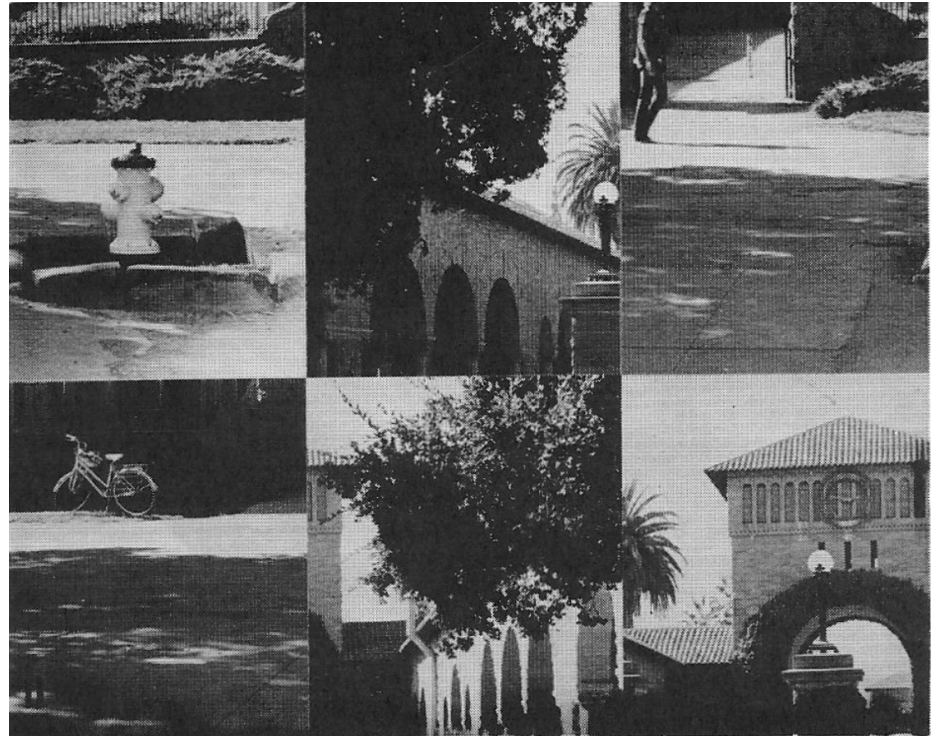

I. Biederman, *Science*, 1972

Rapid Serial Visual Perception (RSVP)

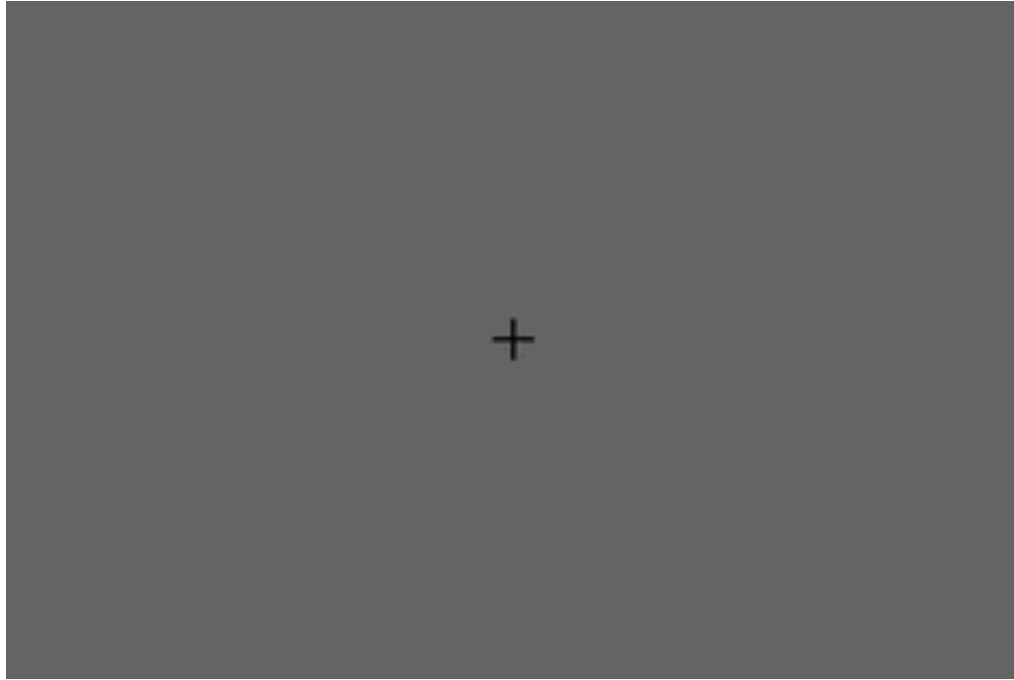

Potter, etc. 1970s

Speed of processing in the human visual system

Simon Thorpe, Denis Fize & Catherine Marlot

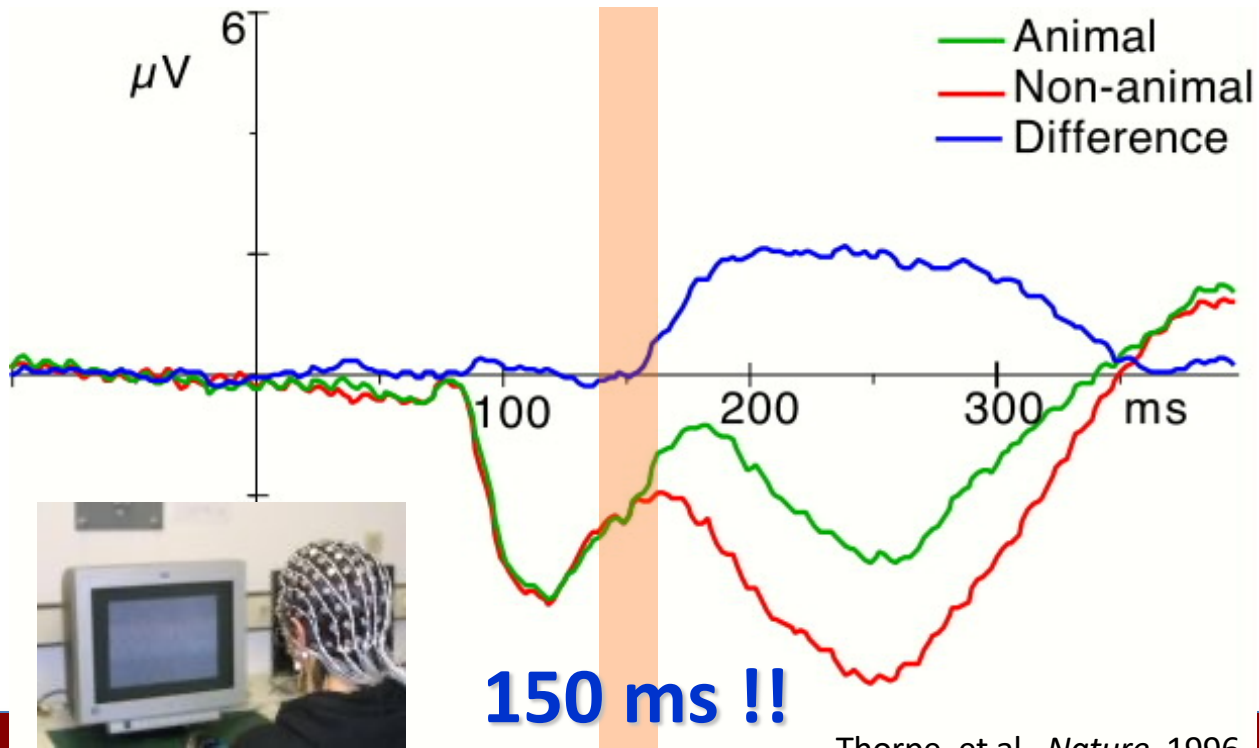

Thorpe, et al. *Nature*, 1996



Neural correlates of object & scene recognition

Faces > Houses

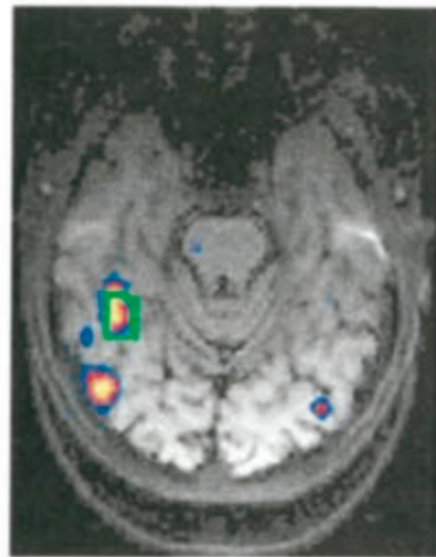

% signal change

Kanwisher et al. J. Neuro. 1997

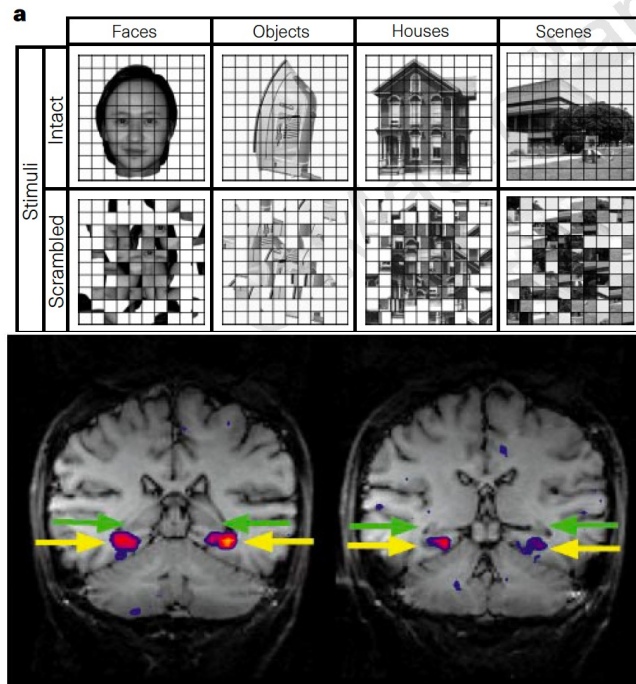

Epstein & Kanwisher, Nature, 1998

Visual recognition is a fundamental task for visual intelligence

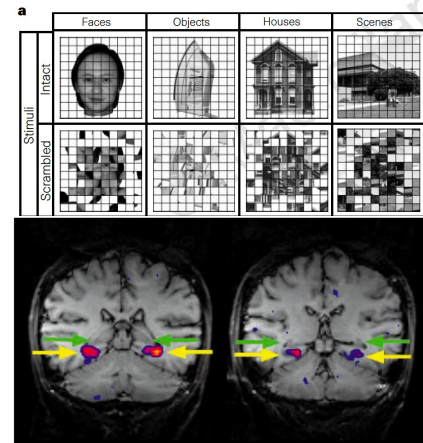

Recognition via Grouping (1990s)



1959
Hubel & Wiesel

1963
Roberts

1970s
David Marr

1979
Gen. Cylinders

1986
Canny

1997
Norm. Cuts

AI Winter

Normalized Cuts, Shi and Malik, 1997

Left Image is CC BY 3.0

Middl Image is public domain

Right Image is CC-BY 2.0; changes made

Slide inspiration: Justin Johnson

Recognition via Matching (2000s)



Image is public domain



Image is public domain

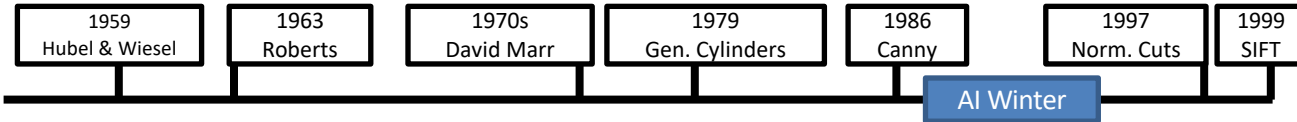

SIFT, David Lowe, 1999

Slide inspiration: Justin Johnson

Face Detection

Viola and Jones, 2001

One of the first successful applications of machine learning to vision

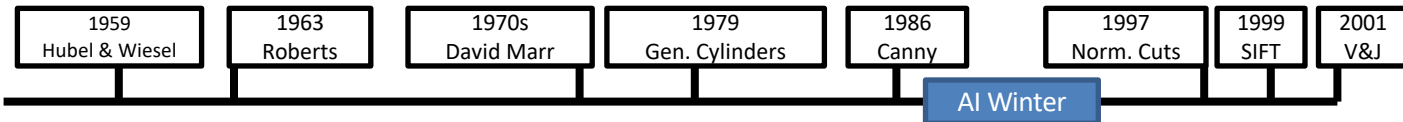
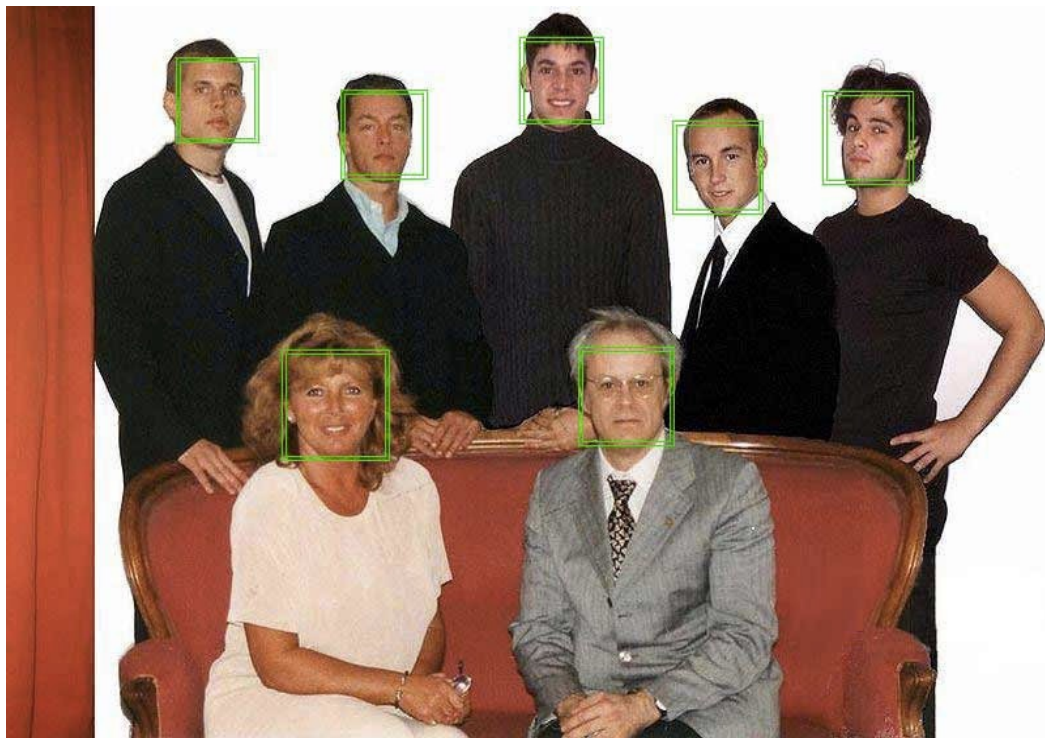

Slide inspiration: Justin Johnson

Caltech 101 images

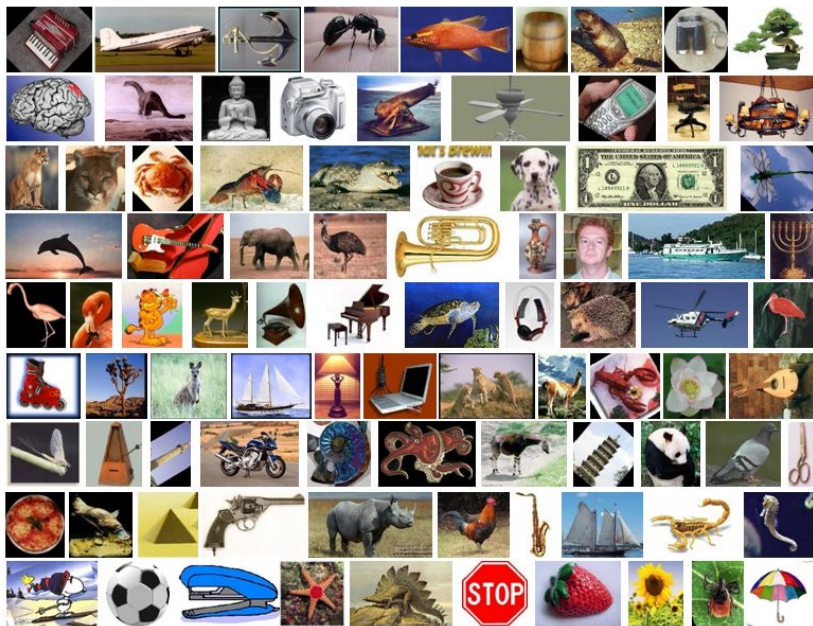

PASCAL Visual Object Challenge

Image is CC0 1.0 public domain

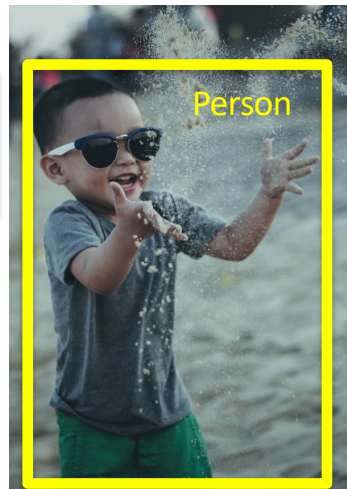
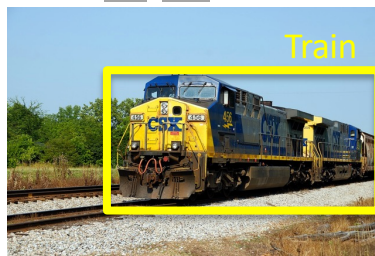
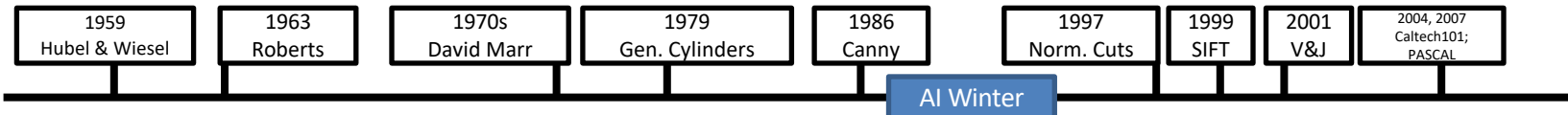

Image is CC0 1.0 public domain



Slide inspiration: Justin Johnson

Learning representations by back-propagating errors

David E. Rumelhart*, Geoffrey E. Hinton†
& Ronald J. Williams*

* Institute for Cognitive Science, C-015, University of California, San Diego, La Jolla, California 92093, USA

† Department of Computer Science, Carnegie-Mellon University, Pittsburgh, Philadelphia 15213, USA

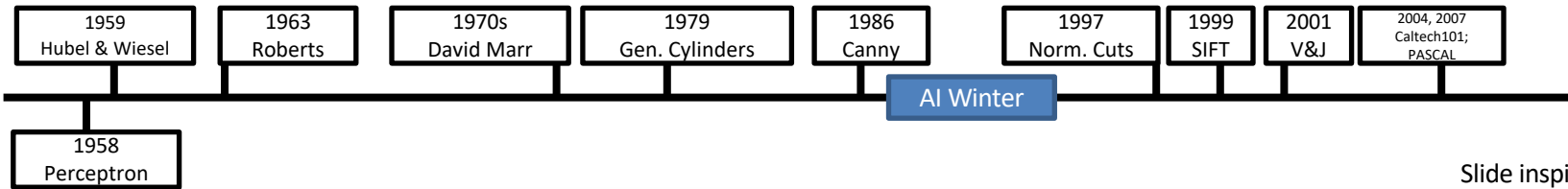
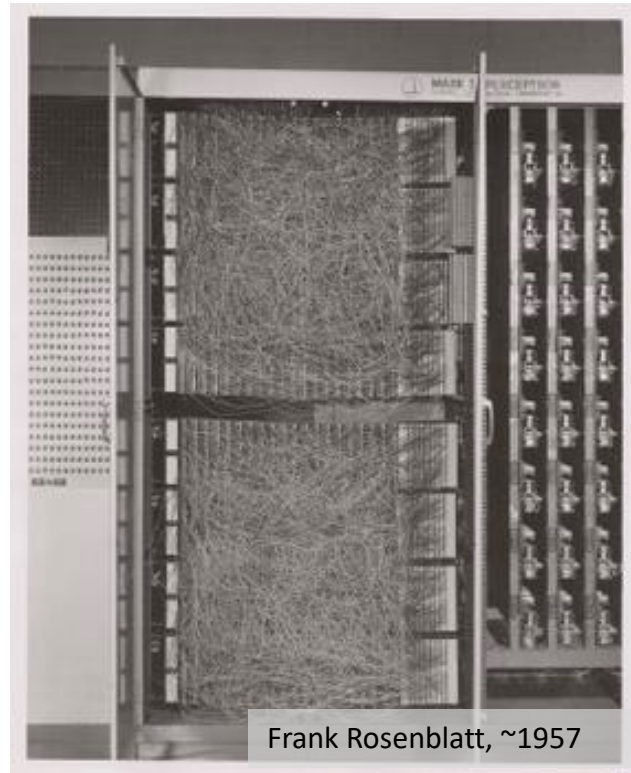
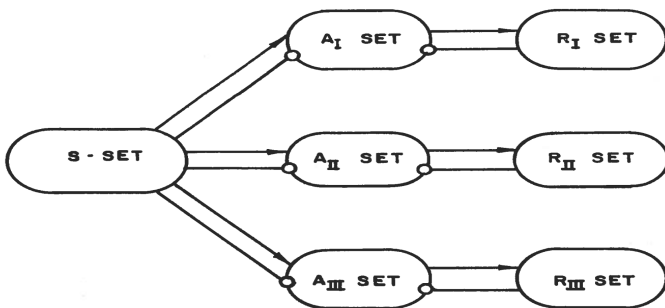

Slide inspiration: Justin Johnson

Minsky and Papert, 1969

X	Y	F(x,y)
0	0	0
0	1	1
1	0	1
1	1	0

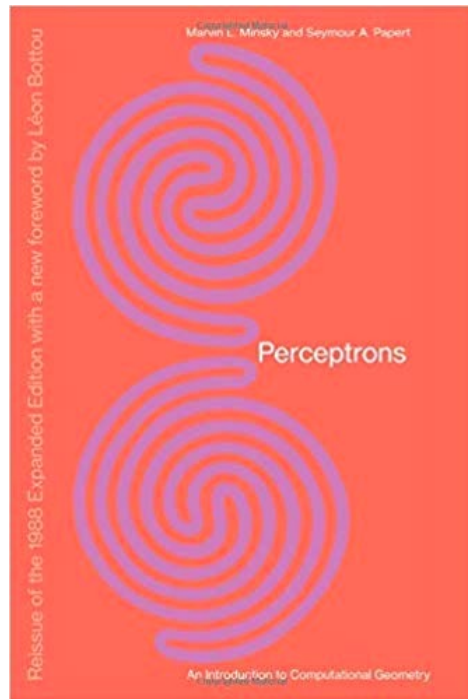
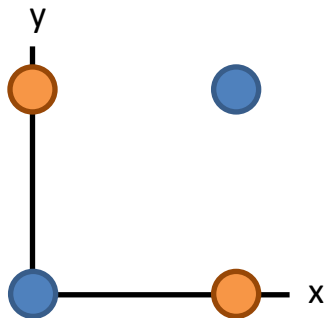

Showed that Perceptrons could not learn the XOR function

Caused a lot of disillusionment in the field

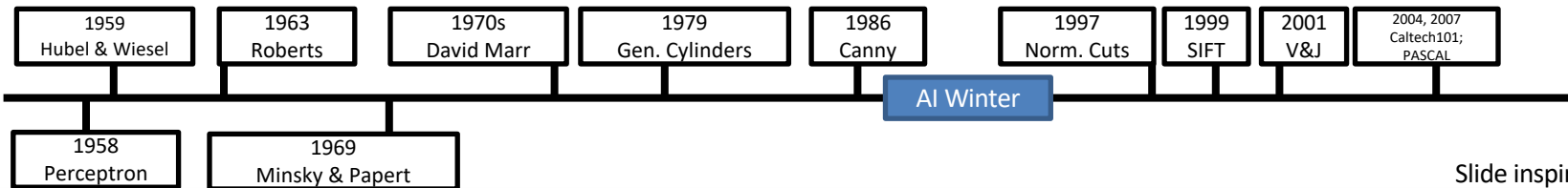

Slide inspiration: Justin Johnson

Neocognitron: Fukushima, 1980

Computational model the visual system,
directly inspired by Hubel and Wiesel's
hierarchy of complex and simple cells

Interleaved simple cells (convolution)
and complex cells (pooling)

No practical training algorithm

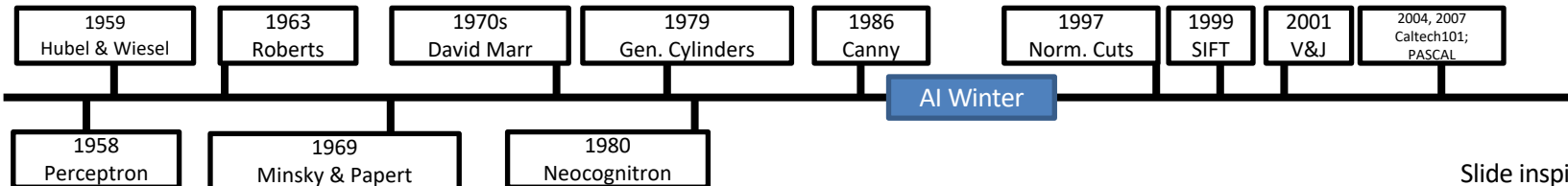
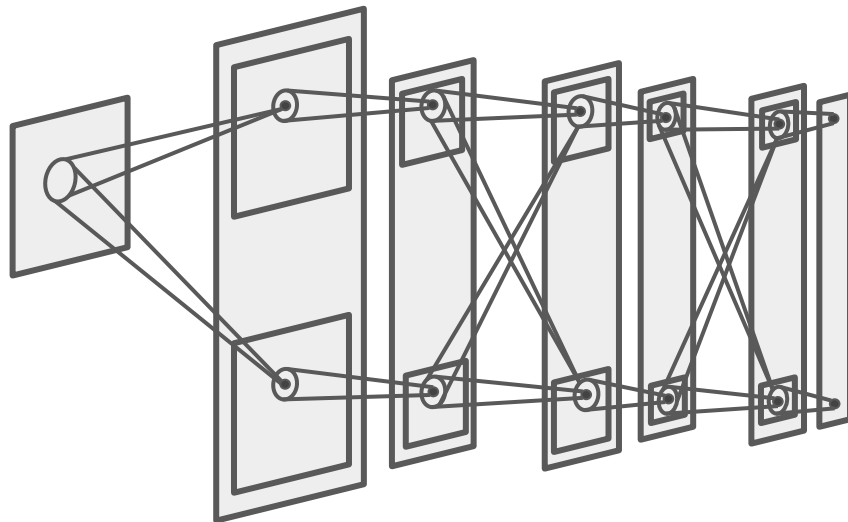

Slide inspiration: Justin Johnson

Backprop: Rumelhart, Hinton, and Williams, 1986

Introduced backpropagation for computing gradients in neural networks

Successfully trained perceptrons with multiple layers

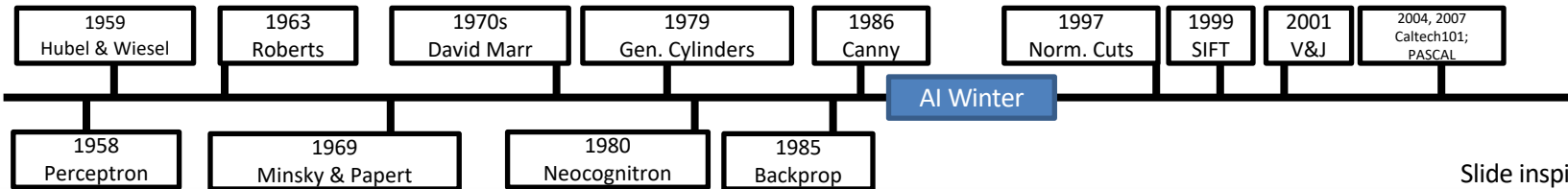
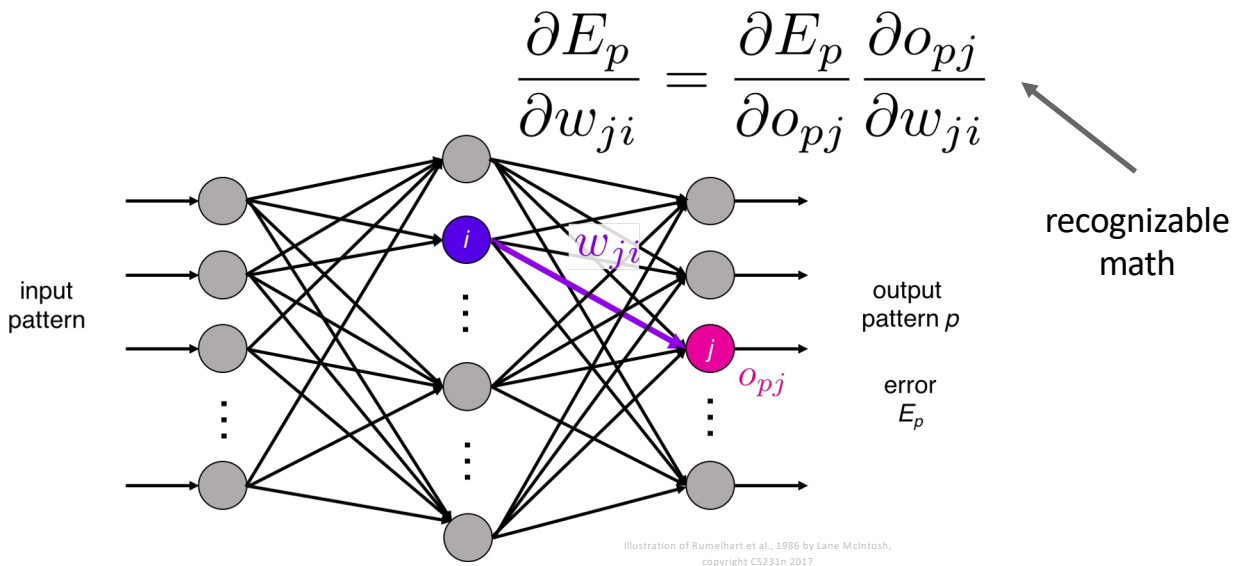

Slide inspiration: Justin Johnson

Convolutional Networks: LeCun et al, 1998

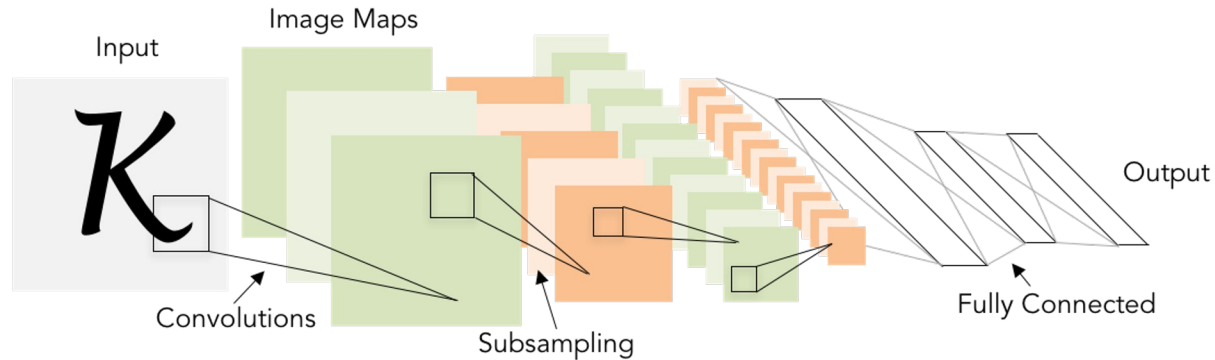

Applied backprop algorithm to a Neocognitron-like architecture

Learned to recognize handwritten digits

Was deployed in a commercial system by NEC, processed handwritten checks

Very similar to our modern convolutional networks!

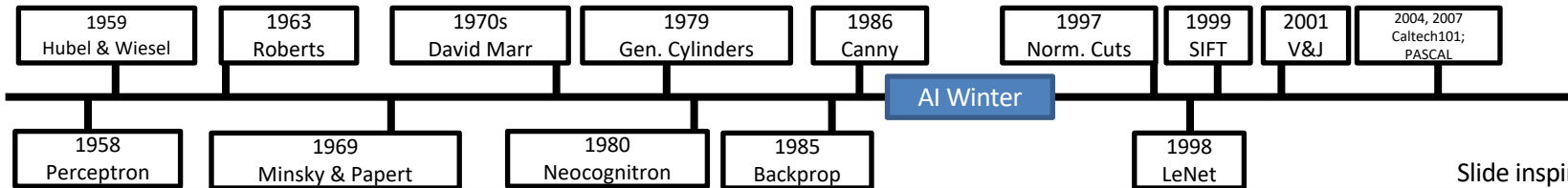

Slide inspiration: Justin Johnson

2000s: “Deep Learning”

People tried to train neural networks that were deeper and deeper

Not a mainstream research topic at this time

Hinton and Salakhutdinov, 2006

Bengio et al, 2007

Lee et al, 2009

Glorot and Bengio, 2010

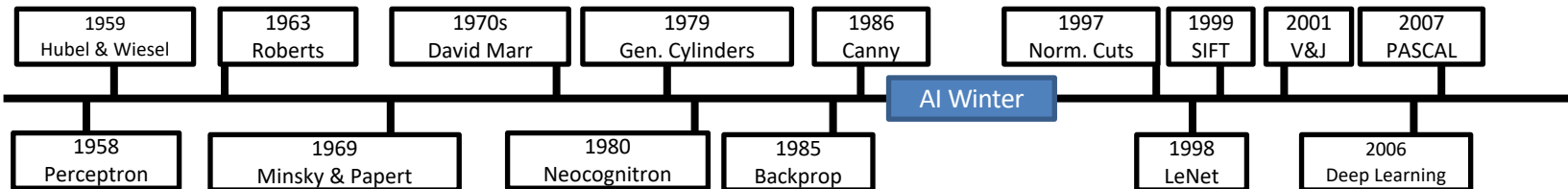
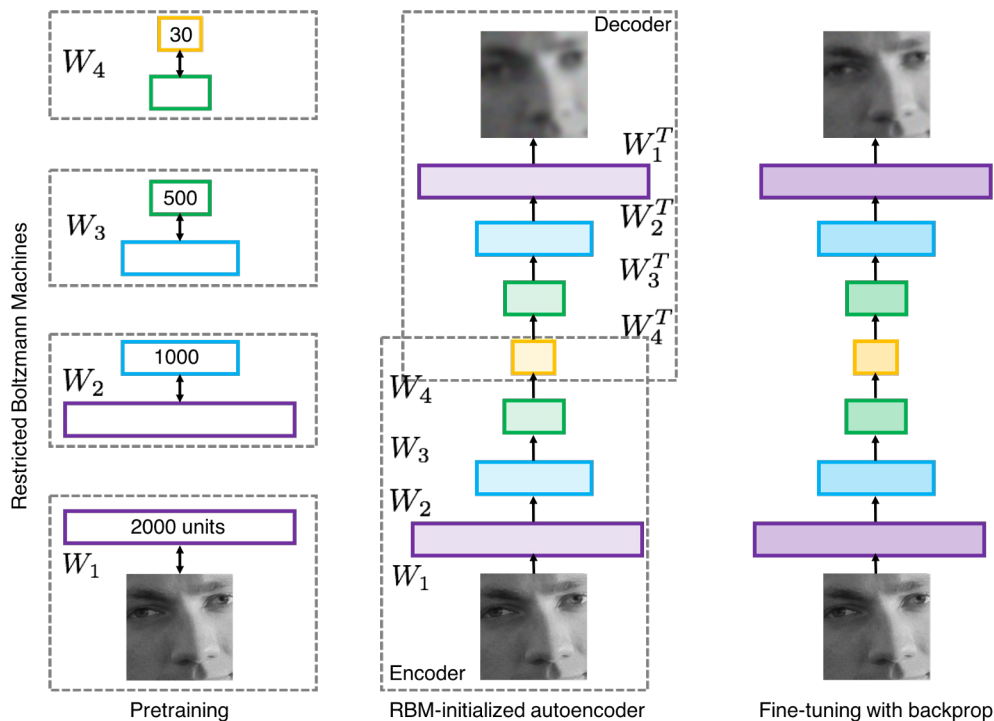

2000s: “Deep Learning”

People tried to train neural networks that were deeper and deeper

Not a mainstream research topic at this time

No good dataset to work on

Hinton and Salakhutdinov, 2006

Bengio et al, 2007

Lee et al, 2009

Glorot and Bengio, 2010

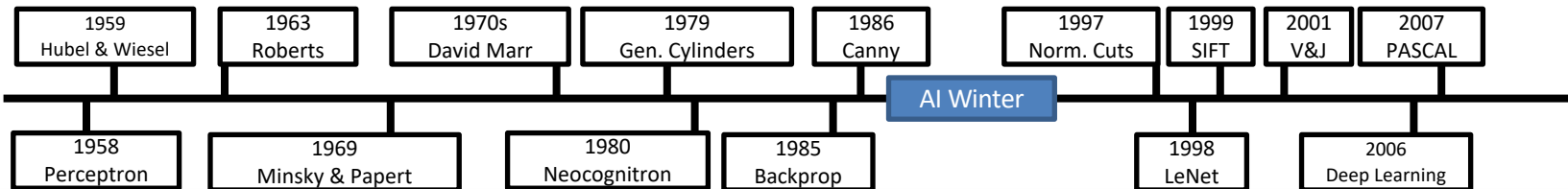
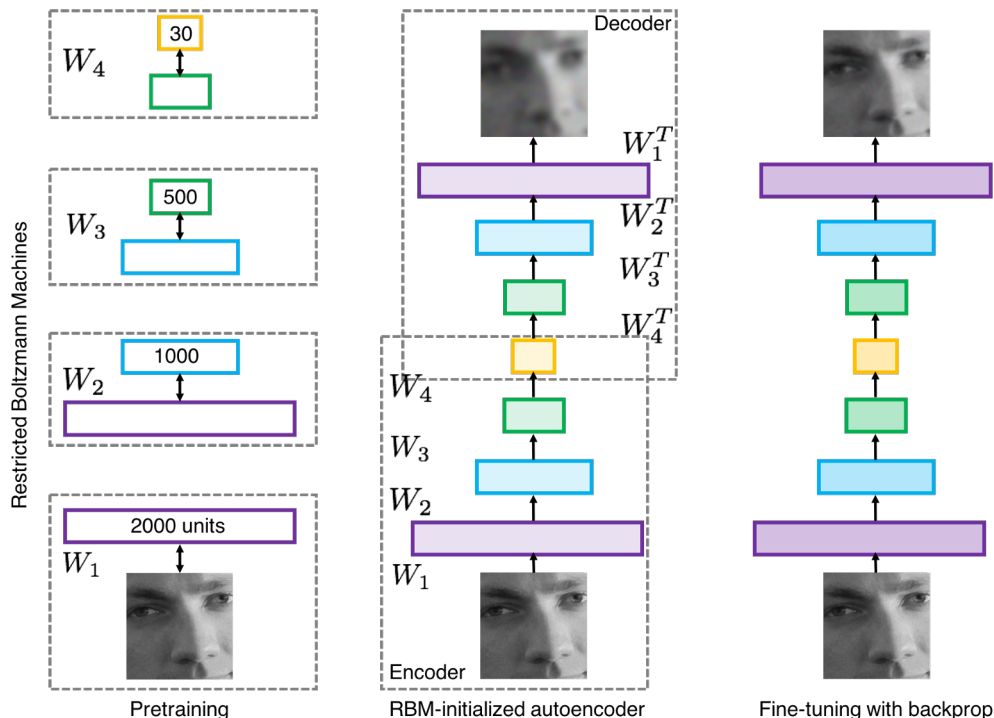

IMAGENET Large Scale Visual Recognition Challenge

The Image Classification Challenge:
1,000 object classes
1,431,167 images



Output:
Scale
T-shirt
Steel drum
Drumstick
Mud turtle

Deng et al, 2009
Russakovsky et al. IJCV 2015

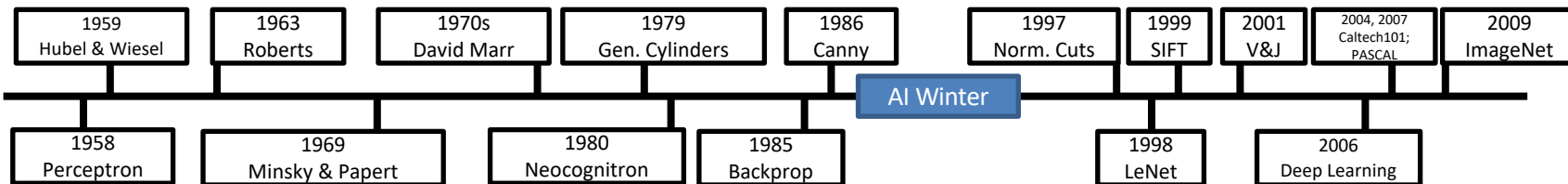

IMAGENET Large Scale Visual Recognition Challenge

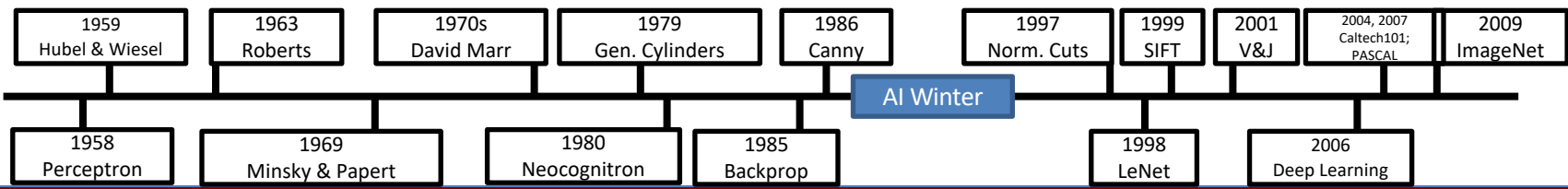
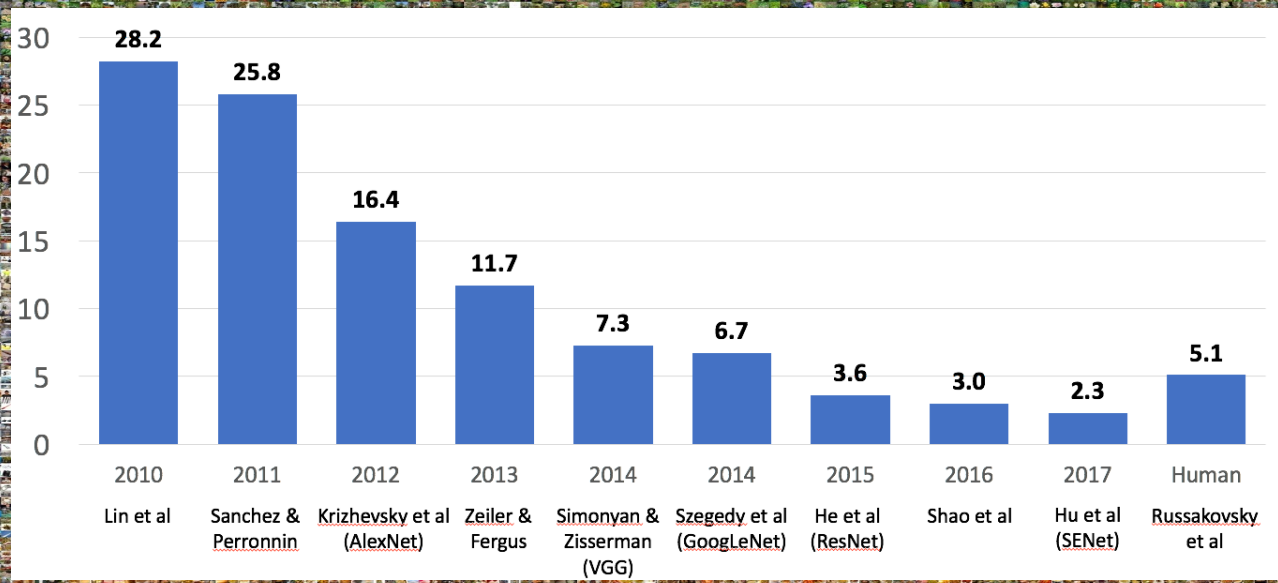

IMAGENET Large Scale Visual Recognition Challenge

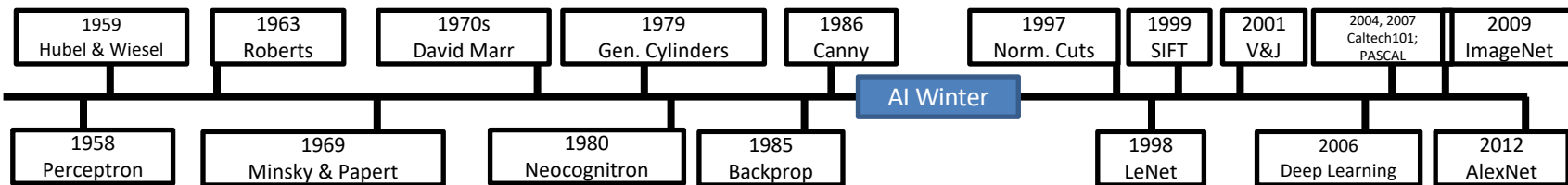
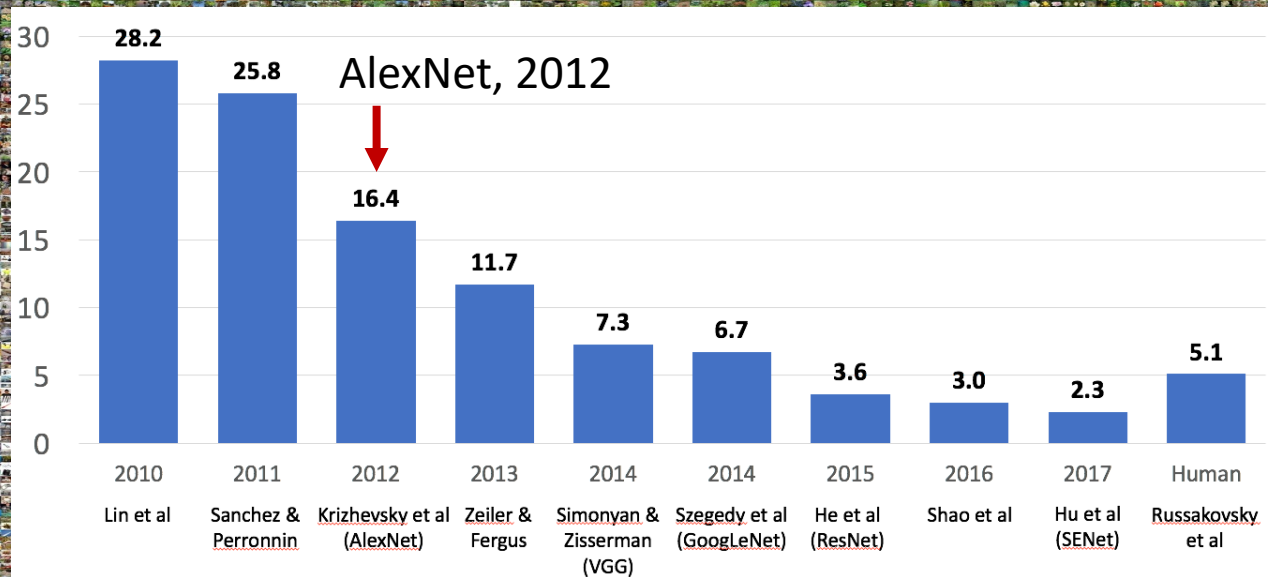

AlexNet: Deep Learning Goes Mainstream

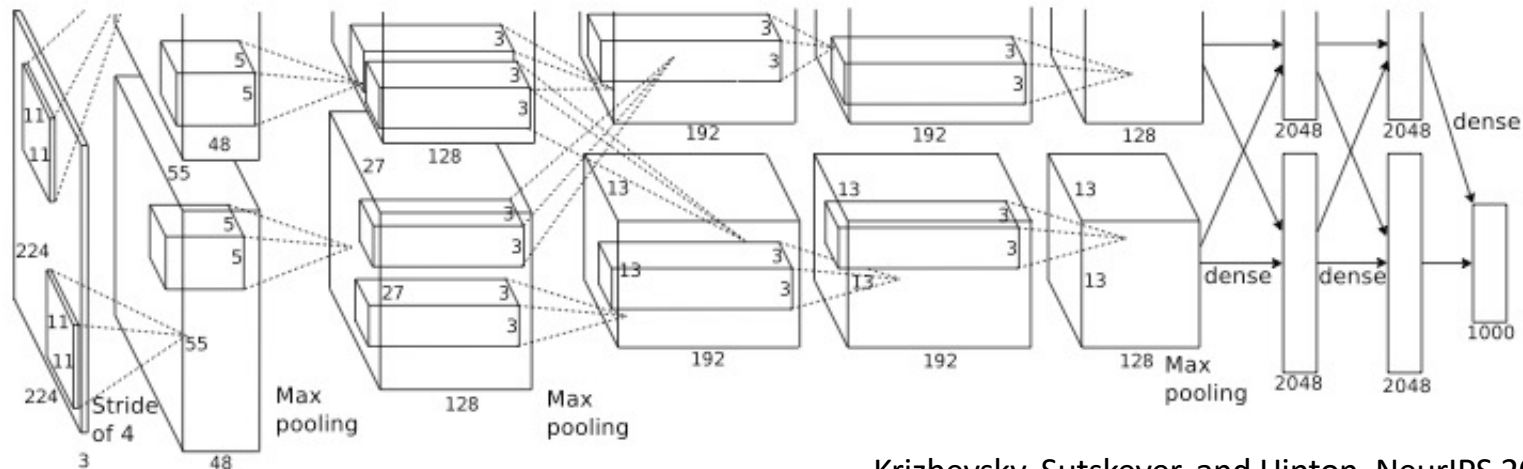

Krizhevsky, Sutskever, and Hinton, NeurIPS 2012

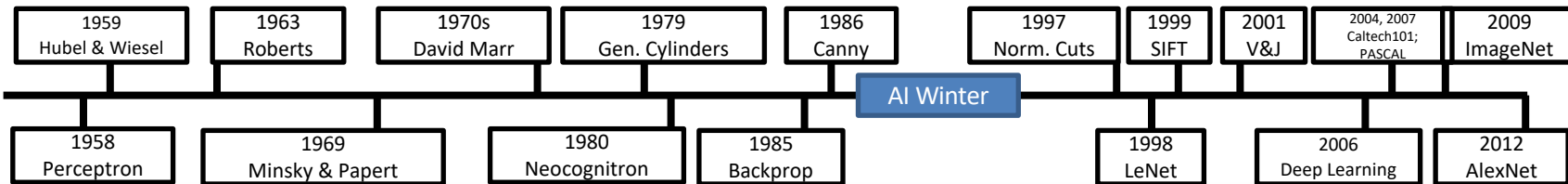

AlexNet vs. Neocognitron: 32 years apart

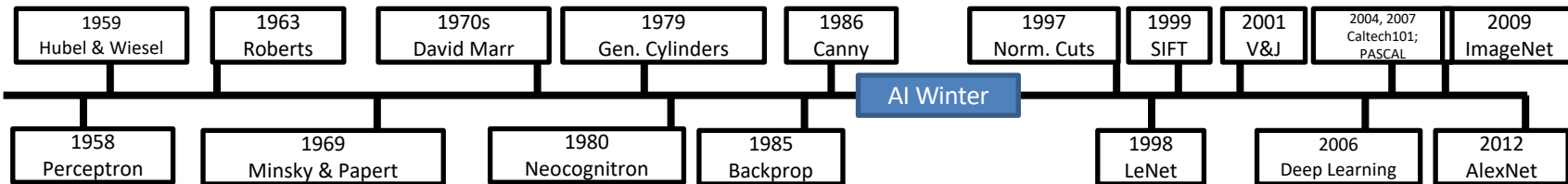
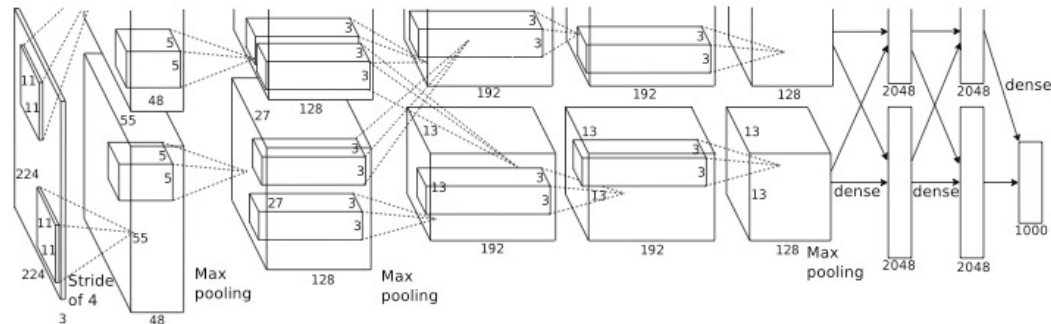
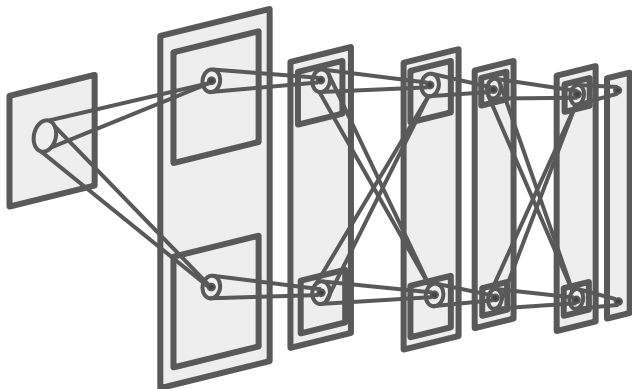

2012 to Present: Deep Learning Explosion

CVPR Papers

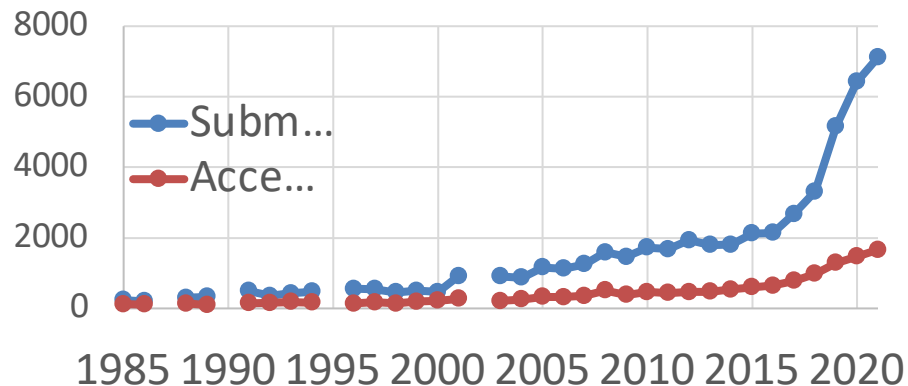

ML+AI arXiv papers per month

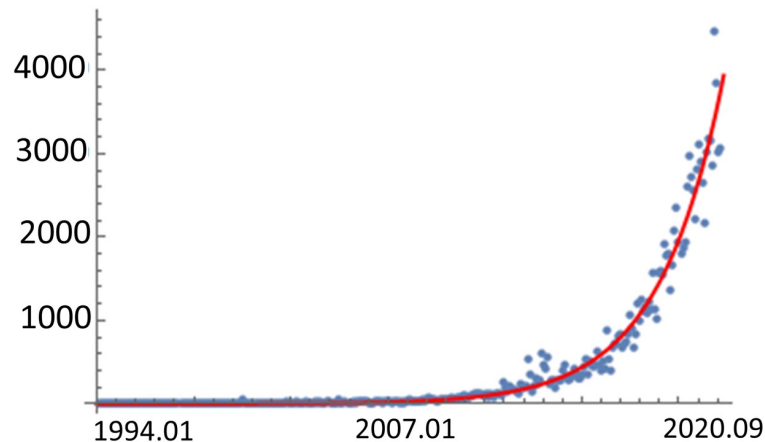

Publications at top Computer Vision conference

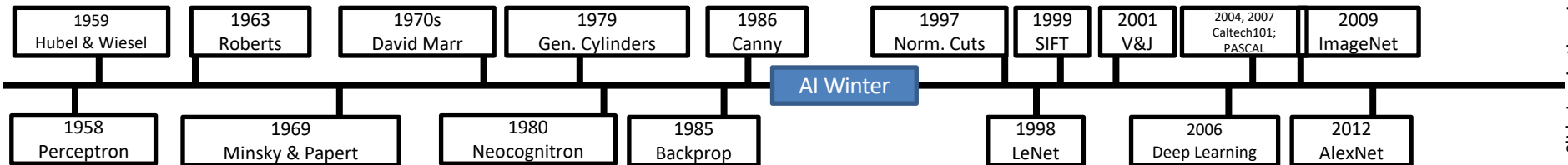

arXiv papers per month [\(source\)](#)

2012 to Present: Deep Learning is Everywhere

Year 2010
NEC-UIUC

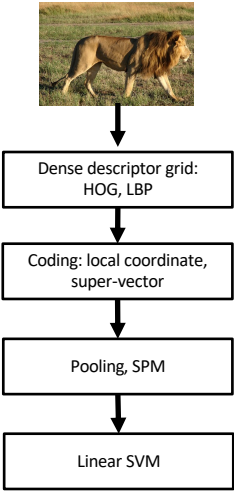

[Lin CVPR 2011]

Lion image by Swissfrog is licensed under CC BY 3.0

Year 2012
SuperVision

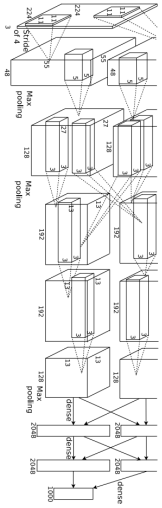

[Krizhevsky NIPS 2012]

Figure copyright Alex Krizhevsky, Ilya Sutskever, and Geoffrey Hinton, 2012. Reproduced with permission.

Year 2014

GoogLeNet

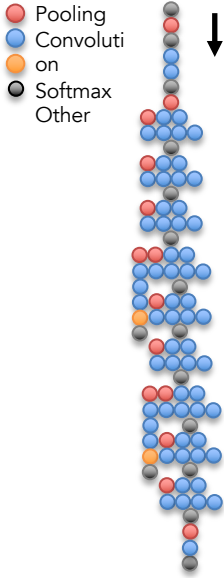

[Szegedy arxiv 2014]

VGG

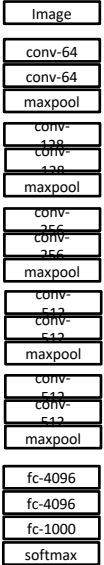

[Simonyan arxiv 2014]

Year 2015

MSRA

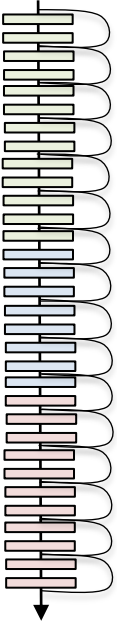

[He ICCV 2015]

2012 to Present: Deep Learning is Everywhere

Image Classification



Image Retrieval

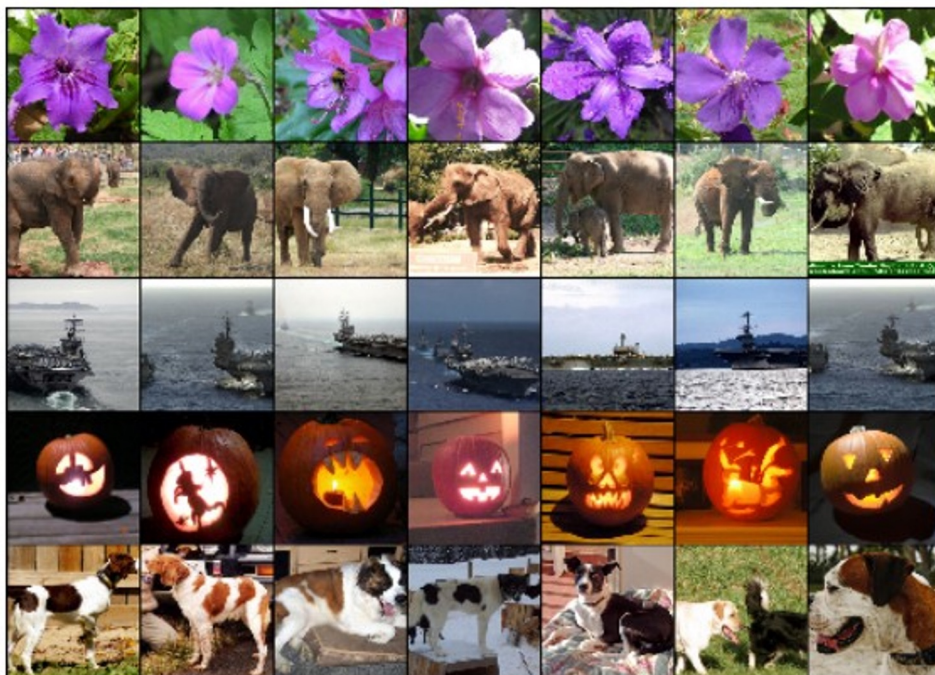

Figures copyright Alex Krizhevsky, Ilya Sutskever, and Geoffrey Hinton, 2012. Reproduced with permission.

2012 to Present: Deep Learning is Everywhere

Video Classification

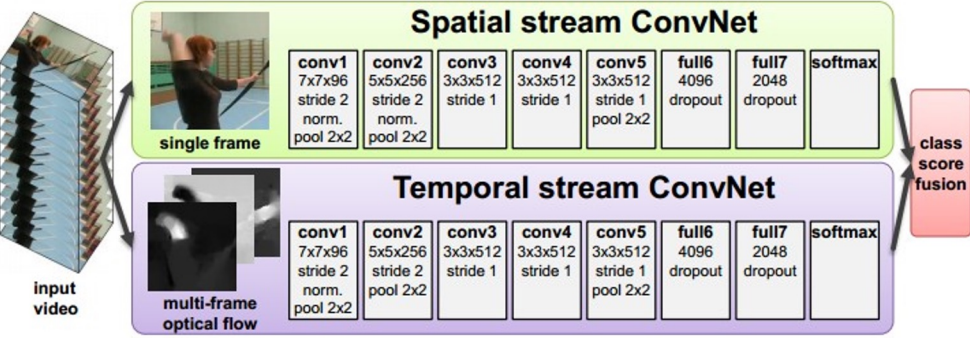

Simonyan et al, 2014

Activity Recognition

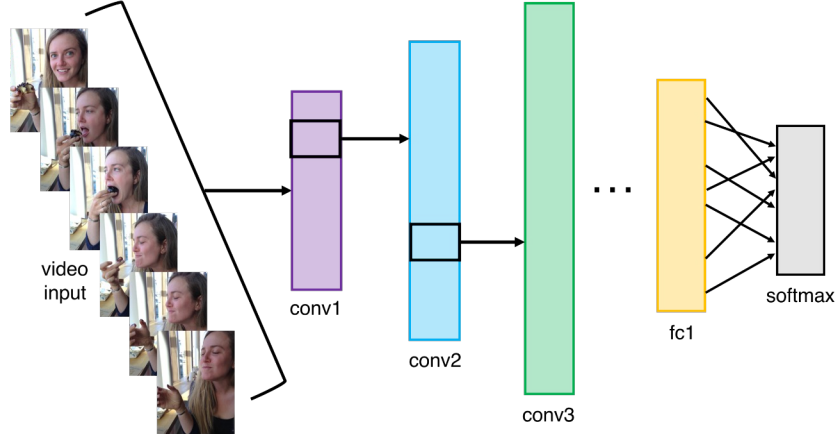

Slide inspiration: Justin Johnson

2012 to Present: Deep Learning is Everywhere

Pose Recognition (Toshev and Szegedy, 2014)



Playing Atari games (Guo et al, 2014)

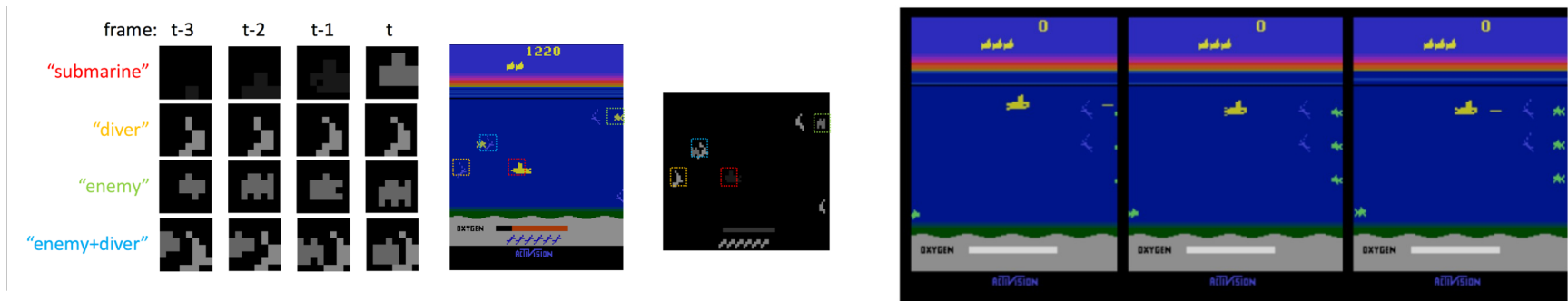

2012 to Present: Deep Learning is Everywhere

Medical Imaging

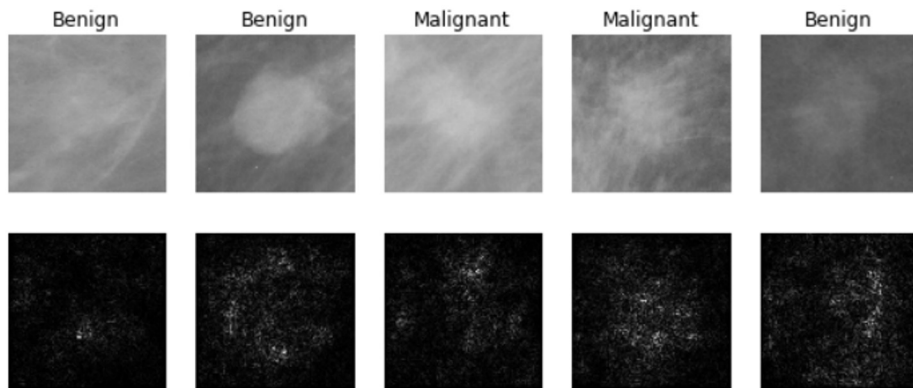

Levy et al, 2016 Figure reproduced with permission

Galaxy Classification



Dieleman et al, 2014

From left to right: [public domain by NASA](#), usage [permitted](#) by ESA/Hubble, [public domain by NASA](#), and [public domain](#)

Whale recognition

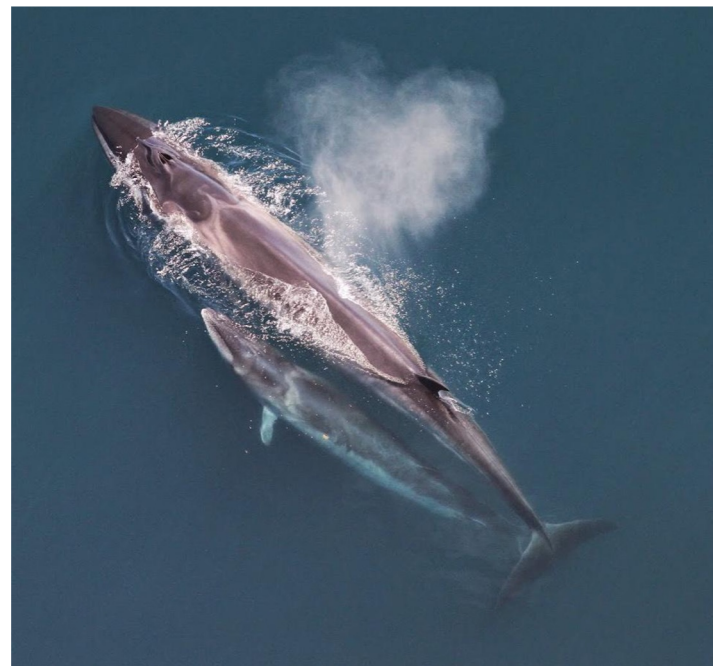

Kaggle Challenge

[This image](#) by Christin Khan is in the public domain and originally came from the U.S. NOAA.

Slide inspiration: Justin Johnson

2012 to Present: Deep Learning is Everywhere



A white teddy bear sitting in the grass



A man in a baseball uniform throwing a ball



A woman is holding a cat in her hand

Image Captioning

Vinyals et al, 2015

Karpathy and Fei-Fei, 2015



A man riding a wave on top of a surfboard



A cat sitting on a suitcase on the floor



A woman standing on a beach holding a surfboard

All images are CC0 Public domain:

<https://pixabay.com/en/flourage-antique-cat-1693010/>
<https://pixabay.com/en/teddy-bear-white-teddy-bear-1623436/>
<https://pixabay.com/en/four-wave-summer-sport-litoral-1668716/>
<https://pixabay.com/en/woman-female-model-portrait-adult-983967/>
<https://pixabay.com/en/handstand-jake-meditation-496008/>
<https://pixabay.com/en/baseball-player-shortstop-infield-1045263/>

Captions generated by Justin Johnson using [NeuralTalk2](#)

2012 to Present: Deep Learning is Everywhere

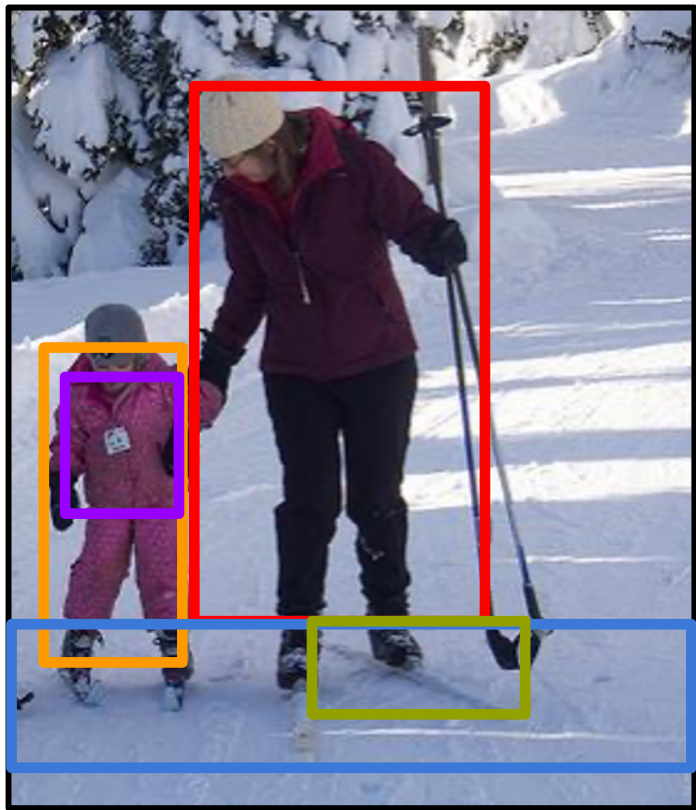

Results:
spatial, comparative, asymmetrical,
verb, prepositional

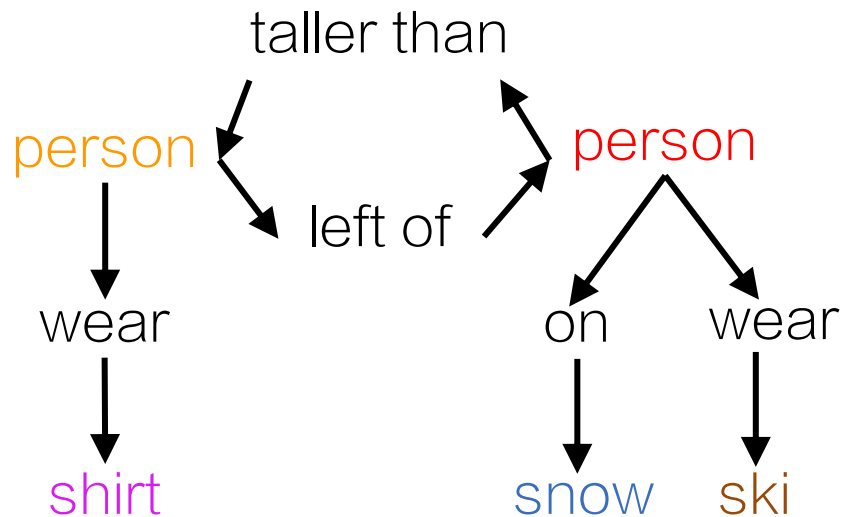

Krishna*, Lu*, Bernstein, Fei-Fei, *ECCV* 2016

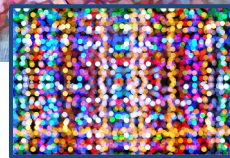
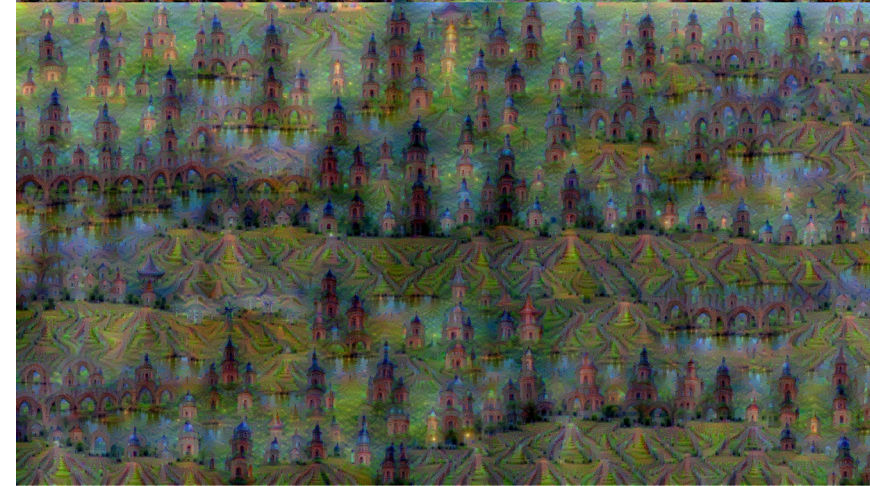
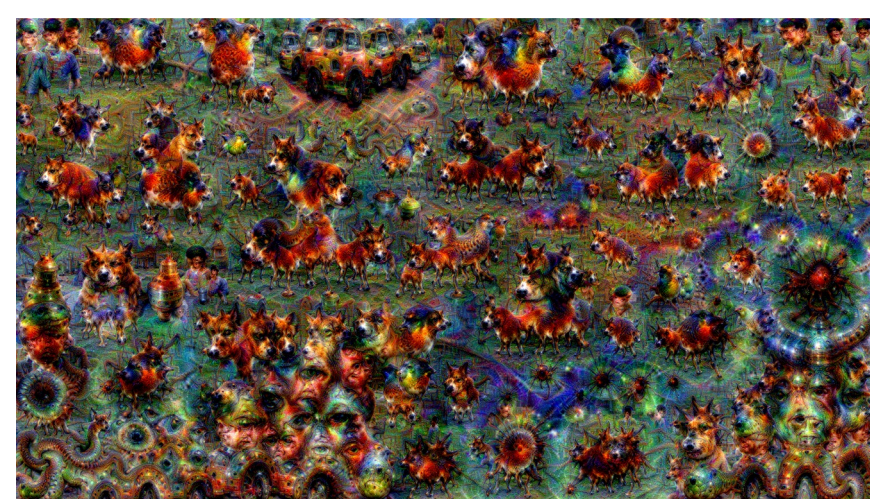

Original image is CC0 public domain
 Starry Night and Tree Roots by Van Gogh are in the public domain
 Boken image is in the public domain
 Stylized images copyright Justin Johnson, 2017;
 reproduced with permission

Figures copyright Justin Johnson, 2015. Reproduced with permission. Generated using the Inceptionism approach from a blog post by Google Research.

Mordvinsev et al, 2015
 Gatys et al, 2016

Slide inspiration: Justin Johnson

2012 to Present: Deep Learning is Everywhere

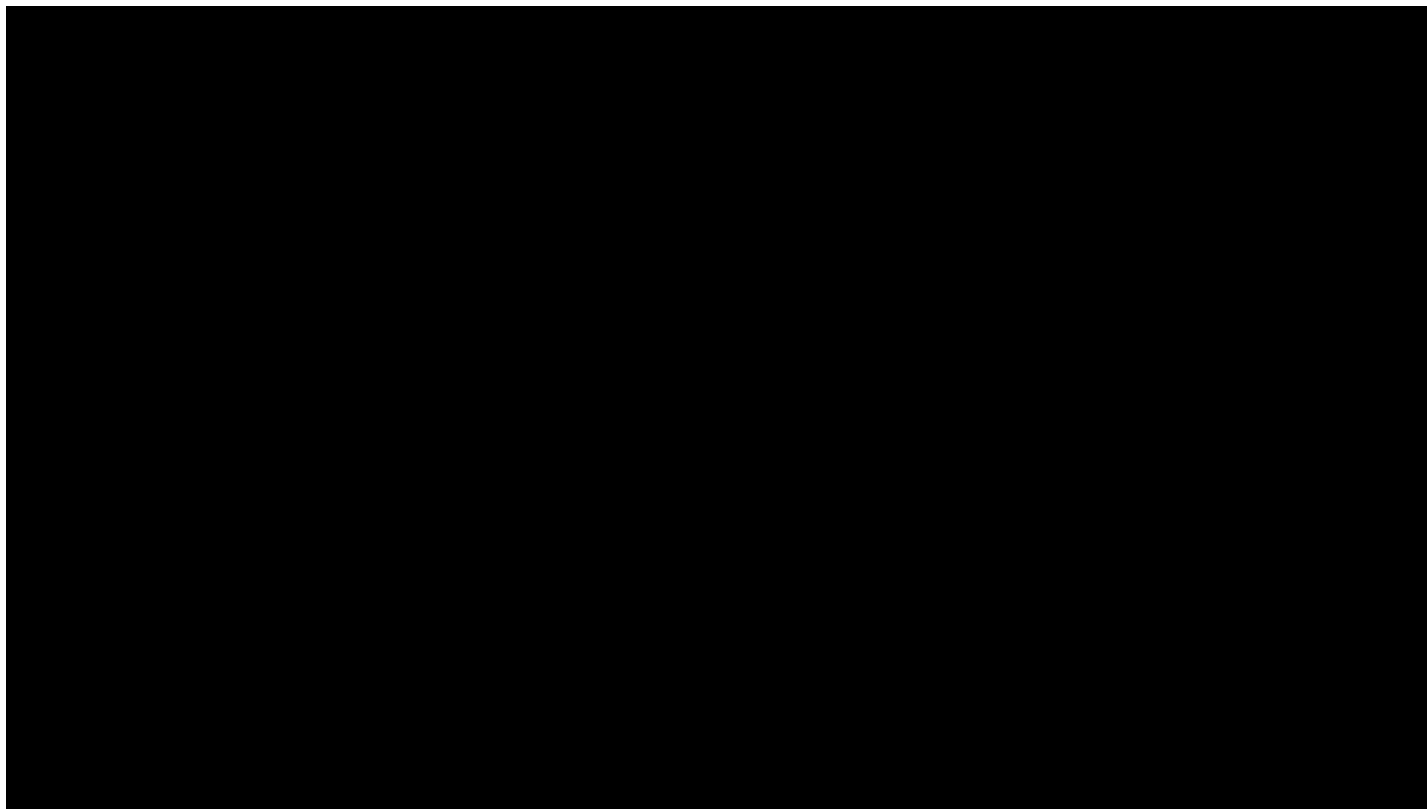

Karras et al, "Progressive Growing of GANs for Improved Quality, Stability, and Variation", ICLR 2018

2012 to Present: Deep Learning is Everywhere

TEXT PROMPT

an armchair in the shape of an avocado. an armchair imitating an avocado.

AI-GENERATED IMAGES



Slide inspiration: Justin Johnson

Ramesh et al, "DALL-E: Creating Images from Text", 2021. <https://openai.com/blog/dall-e/>

2012 to Present: Deep Learning is Everywhere

TEXT PROMPT

an armchair in the shape of a peach. an armchair imitating a peach.

AI-GENERATED IMAGES

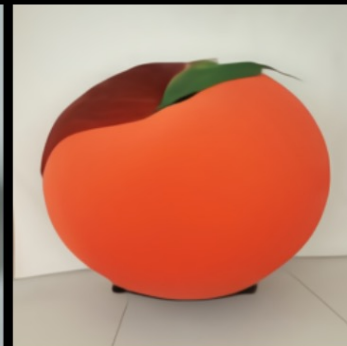
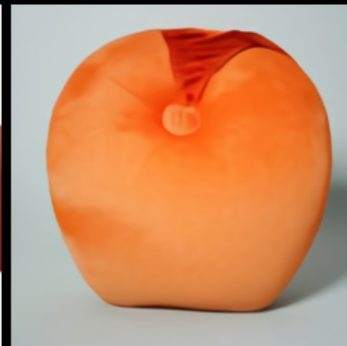
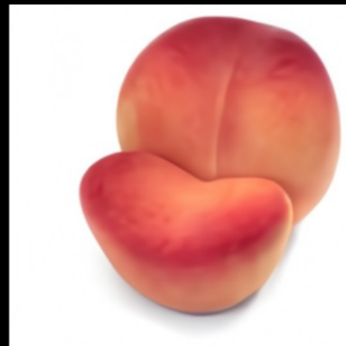



Computation

April 2, 2024

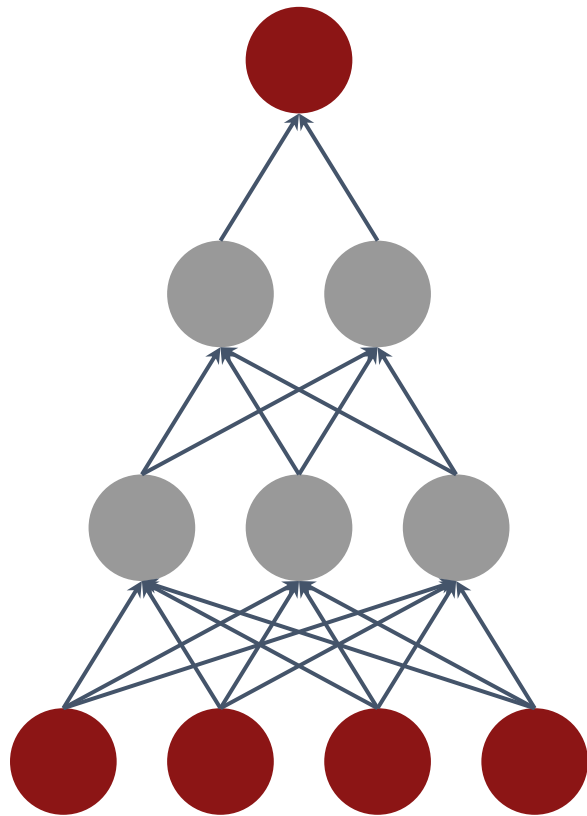

Algorithms



Data

GFLOP per Dollar

● CPU ● GPU (FP32)

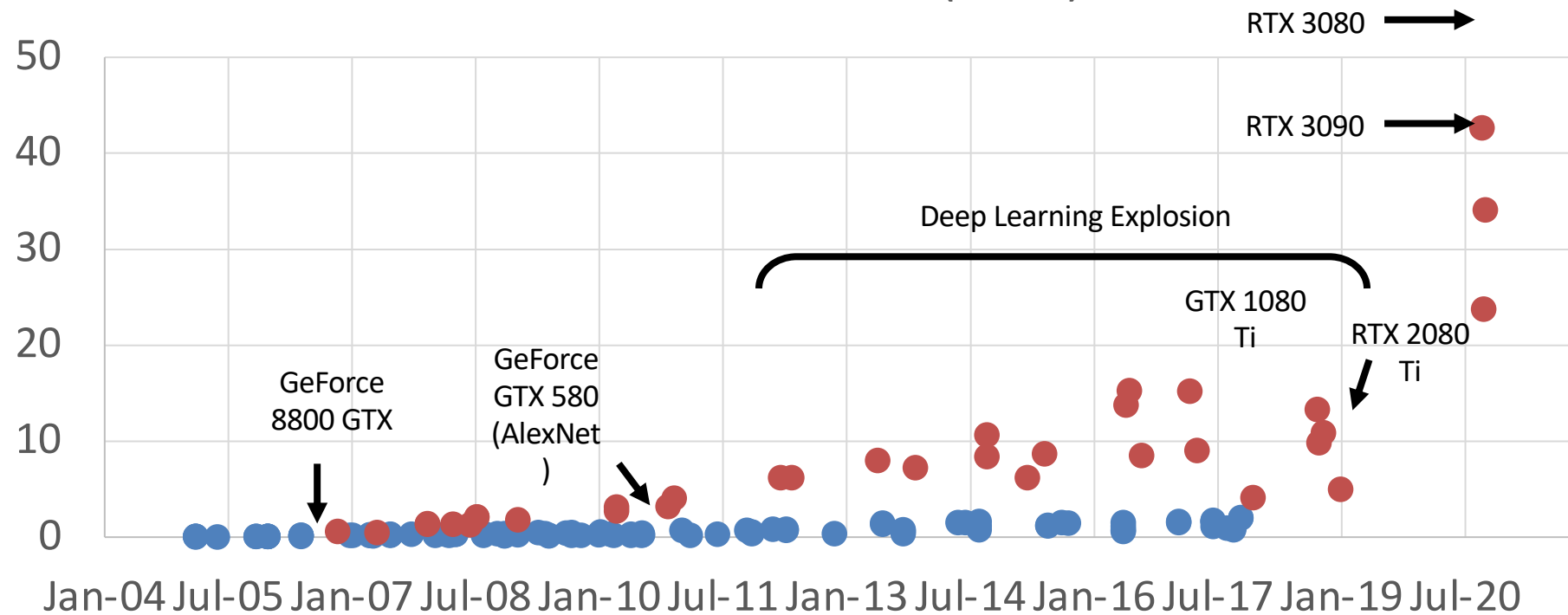

Slide inspiration: Justin Johnson

GFLOP per Dollar

● CPU ● GPU (FP32) ● GPU (Tensor Core)

Recent GPUs have
"Tensor Cores":
Special hardware
for deep learning!

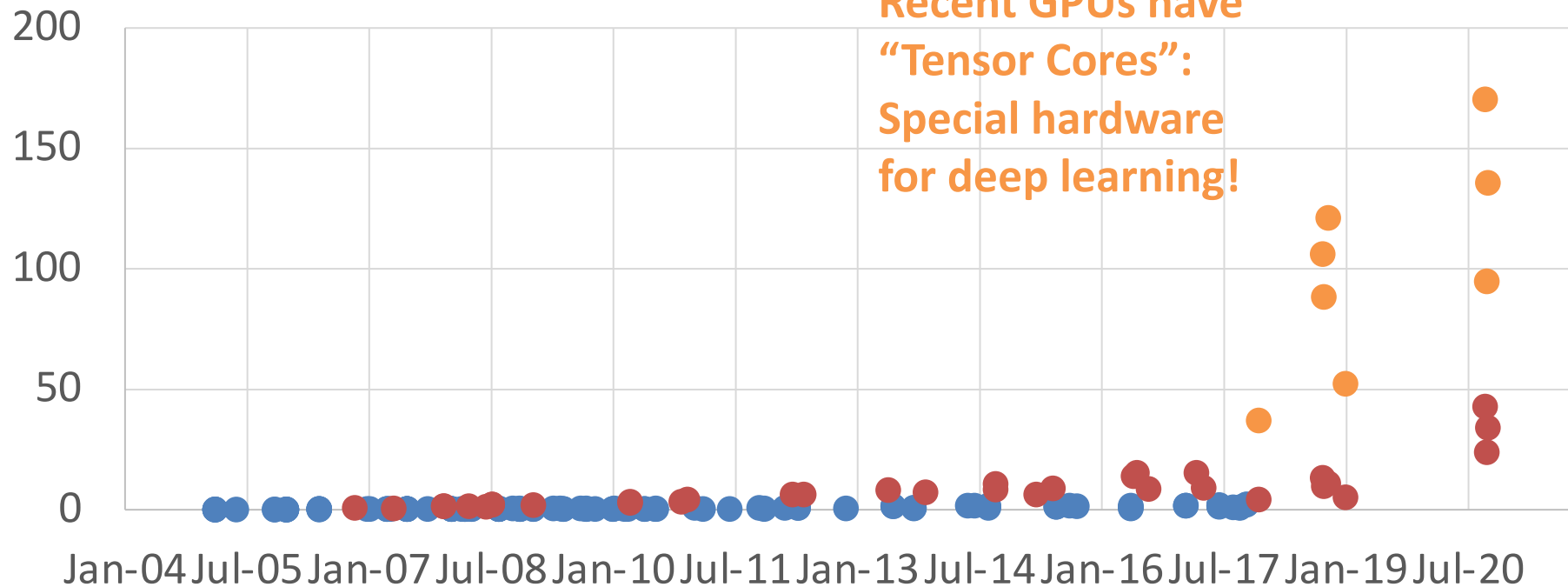

AI's Explosive Growth & Impact

Attendance at large conferences (1984-2019)
Source: Conference provided data.

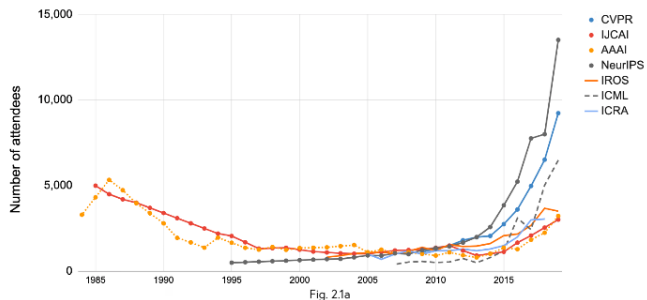

Number of attendance At AI conferences

Source: The Gradient

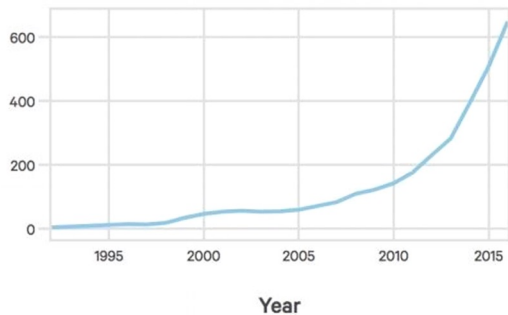

Startups Developing AI Systems

Source: Crunchbase, VentureSource, Sand Hill Econometrics

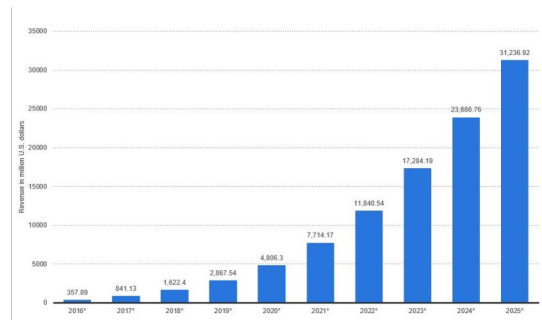

Enterprise Application AI Revenue

Source: Statista

Despite the successes, computer vision still has a long way to go

Computer Vision Can Cause Harm

Harmful Stereotypes

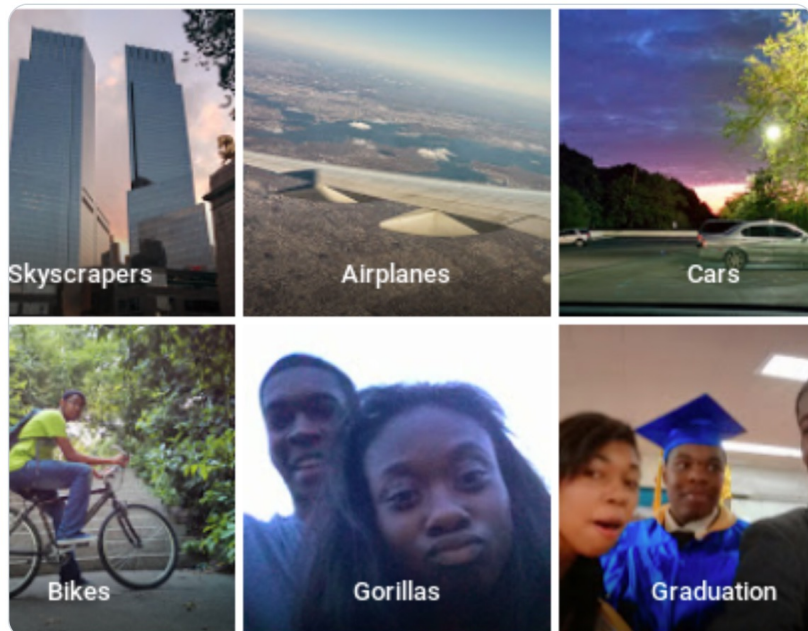

Affect people's lives

Technology

A face-scanning algorithm increasingly decides whether you deserve the job

HireVue claims it uses artificial intelligence to decide who's best for a job. Outside experts call it 'profoundly disturbing.'

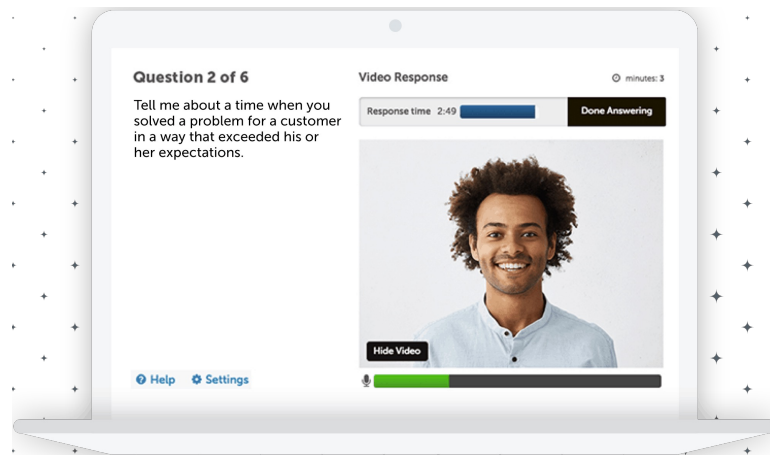

Barocas et al, "The Problem With Bias: Allocative Versus Representational Harms in Machine Learning", SIGCIS 2017
Kate Crawford, "The Trouble with Bias", NeurIPS 2017 Keynote
Source: <https://twitter.com/jackyalcine/status/615329515909156865> (2015)

Source: <https://www.washingtonpost.com/technology/2019/10/22/ai-hiring-face-scanning-algorithm-increasingly-decides-whether-you-deserve-job/>
<https://www.hirevue.com/platform/online-video-interviewing-software>

Example Credit: Timnit Gebru

Computer Vision Can Save Lives

How to take care of seniors while keeping them safe?



Early Symptom Detection of COVID-19



Monitor Patients with Mild Symptoms



Manage Chronic Conditions



Versatile



Mobility



Infection



Sleep



Diet



Scalable



Low-cost



Burden-free



And there is a lot we don't know how to do



https://fedandfit.com/wp-content/uploads/2020/06/summer-activities-for-kids_optimized-scaled.jpeg



This image is
copyright-free [United States government work](#)

Slide inspiration: Andrej Karpathy

Today's agenda

- A brief history of computer vision & deep learning
- CS231n overview